



Residential Provisions of the 2018 International Energy Conservation Code

Why care about IECC?

- Energy codes and standards set minimum efficiency requirements for new and renovated buildings, assuring reductions in energy use and emissions over the life of the building. Energy codes are a subset of building codes, which establish baseline requirements and govern building construction.
- Code buildings are more comfortable and cost-effective to operate, assuring energy, economic and environmental benefits.

The Family of I-Codes



- ✓ International Building Code
- ✓ International Mechanical Code
- ✓ International Fuel Gas Code
- ✓ International Property Maintenance Code
- ✓ International Fire Code
- ✓ International Zoning Code
- ✓ International Plumbing Code
- ✓ International Existing Building Code
- ✓ International Private Sewage Disposal Code
- ✓ International Performance Code
- ✓ International Residential Code
- ✓ **International Energy Conservation Code**
- ✓ International Wildlife-Urban Interface Code



Relationship Between IRC & IECC

- ✓ IECC addresses only energy
- ✓ IRC addresses all topics (*structural, plumbing, etc.*)
 - Allows builder to carry only one code book
 - Chapter 11 covers energy efficiency
- ✓ As of 2015, IECC consolidated with IRC energy chapter (actually a change to the IRC, not the IECC).
- ✓ IECC addresses both residential and commercial; IRC addresses subset of residential, detached one- and two-family dwellings and townhouses 3 stories or fewer

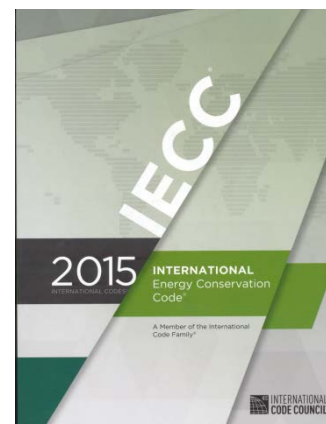

VS

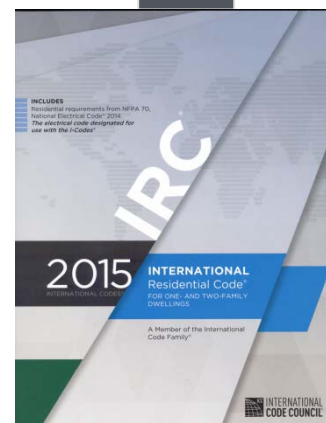

A graphic for the Commercial Section header, featuring a brown semi-circle on the left and a green semi-circle on the right, both overlapping a white rectangular box with a green border. The box is divided into two horizontal sections: the top section contains the word "Commercial" and the bottom section contains the word "Section".

Commercial Section

- Ch. 1 Scope and Application /
Administrative and
Enforcement
- Ch. 2 Definitions
- Ch. 3 General Requirements
- Ch. 4 Commercial Energy Efficiency
- Ch. 5 Existing Buildings
- Ch. 6 Referenced Standards
- Index

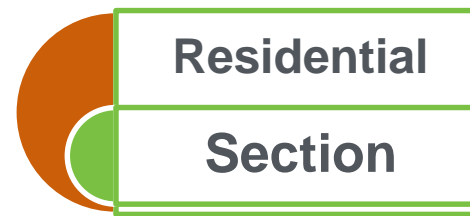
A graphic for the Residential Section header, featuring a brown semi-circle on the left and a green semi-circle on the right, both overlapping a white rectangular box with a green border. The box is divided into two horizontal sections: the top section contains the word "Residential" and the bottom section contains the word "Section".

Residential Section

- Ch. 1 Scope and Application /
Administrative and
Enforcement
- Ch. 2 Definitions
- Ch. 3 General Requirements
- Ch. 4 Residential Energy Efficiency
- Ch. 5 Existing Buildings
- Ch. 6 Referenced Standards
- Index



Residential Buildings:

- ✓ One- and two-family dwellings, townhouses of any size and R-2, R-3, R-4 \leq 3 stories
- ✓ All buildings that are not “residential” by definition are “commercial”



Scope

Section R101.4.1 - Mixed Residential and Commercial Buildings

Section R101.5 - Compliance

- ✓ Treat the residential **building portion** under the applicable residential code
- ✓ Treat the commercial **building portion** under the commercial code
- ✓ Code Official has final authority
 - Compliance materials, software, worksheets

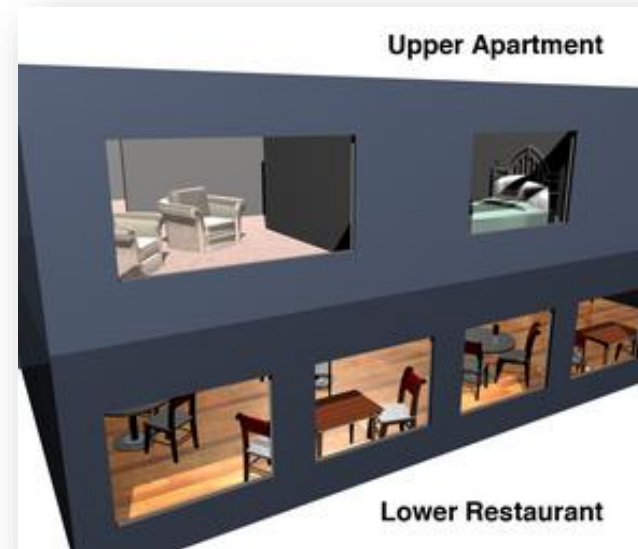

Scope

Section R102.1 – Alternative Materials, Design, and Methods of Construction and Equipment

- The code is not intended to prevent installation of any material or prohibit design or method of construction that is not specifically prescribed in this code
- Such material, equipment, or design shall be approved by the code official
 - If code official doesn't approve, will state reasons in writing

Scope/Construction Documents

Section R103

- ✓ Documentation shall be prepared by a registered design professional (where required)
- ✓ Electronic media can be used
- ✓ Information required:
 - ✓ Insulation materials and R-values
 - ✓ Fenestration U-factors, SHGC
 - ✓ Area-weighted U-factor and SHGC calculations
 - ✓ Mechanical, SWH, equipment types, sizes, and efficiencies
 - ✓ Equipment and system controls
 - ✓ Duct sealing, duct and pipe insulation and location
 - ✓ Air sealing details



The building thermal envelope shall be represented

- ✓ Fees, R104
- ✓ Inspections, R105
 - ✓ Work remains visible and accessible for inspection
- ✓ Code Validity, R106
 - Portions of code deemed to be illegal or void shall not affect the remainder of the code
- ✓ Referenced codes and standards, R107
 - Considered part of the requirements of the code, but IECC provisions take precedence
- ✓ Stop Work Order, R108
 - ✓ Authority of code official
 - ✓ Failure to Comply subject to fine
- ✓ Board of Appeals, R109

- Construction work for which a permit is required is subject to inspection by code official or designated agent
- Required inspections include:
 - Footing and foundation
 - Framing and rough-in
 - Plumbing rough-in
 - Mechanical rough-in
 - Final

Codes and standards listed in Chapter 5 are considered part of the requirements of this code to the “prescribed extent of each such reference and as further regulated in Sections R107.1.1 and R107.1.2”

- Conflicts, R107.1.1 – where differences occur between this code and the referenced codes and standards, provisions of this code apply
- Provisions in reference codes and standards, R107.1.2 – “where the extent of the reference to a referenced code or standard includes subject matter that is within the scope of this code, the provisions of this code, as applicable, shall take precedence over the provisions in the referenced code or standard”

- ✓ Permanently posted on a wall in the space where the furnace is located, a utility room or an approved location inside the building
- ✓ Don't cover or obstruct the visibility of other required labels
- ✓ Includes the following:
 - R-values of insulation installed for the thermal building envelope, including ducts outside conditioned spaces
 - U-factors and SHGC for fenestration
 - Area-weighted U-factor and SHGC calculations
 - Results from any required duct system and building envelope air leakage testing
 - HVAC efficiencies and types
 - SWH equipment
 - Duct sealing, duct and pipe insulation and location
 - Air sealing details

Certificate indicates “gas-fired unvented room heater”, “electric furnace”, or “baseboard electric heater”, rather than indicating an efficiency for those heating types

Climate-Specific Requirements:

- ✓ Roofs
- ✓ Above grade walls
- ✓ Foundations
 - Basements
 - Slabs
 - Crawlspace
- ✓ Skylights, windows, and doors
- ✓ Solar Heat Gain Coefficient in warm climates

Mandatory Requirements (*apply everywhere*):

- ✓ Infiltration control
- ✓ Duct insulation, sealing & testing, no use of building cavities
- ✓ HVAC controls
- ✓ Piping Insulation and circulating service hot water requirements
- ✓ Equipment sizing
- ✓ Dampers
- ✓ Lighting

IECC Terminology

✓ Prescriptive

- Required but can be lessened or eliminated in trade for compensating improvements elsewhere

✓ Mandatory

- Required and cannot be traded down, even in the simulated performance path or Energy Rating Index path
- **Note: Unlike simulated performance path, ERI path is not directly based on the prescriptive requirements**

Some elements have “hard limits”

- ✓ aka, “trade-off limits” or “backstops”
- ✓ a prescriptive requirement that can only be traded so far
- ✓ components can only be traded so far when complying with the performance requirements or ERI path

IECC Terminology

- ✓ "Climate Zone" has two components
 - Eight temperature-oriented zones (1-8)
 - Three named moisture regimes (moist, dry, marine)
 - Theoretically $8 \times 3 = 24$ distinct zones, but only 15 occur in U.S.
- ✓ Two additional climate specifications influence requirements
 - Warm-Humid line delineates counties that are warm-humid as defined by ASHRAE, with exceptions (affects only bsmt reqm'ts)
 - The "Tropical Climate Zone" (not a separate zone) defines areas in which simplified/relaxed requirements apply under some conditions

Climate Zones in the U.S. are entirely geographical

- ✓ Defined along state/county lines
- ✓ International locations defined by local climate data (mean Temp, precipitation, humidity, etc.)

Climate Zones for the 2018 IECC

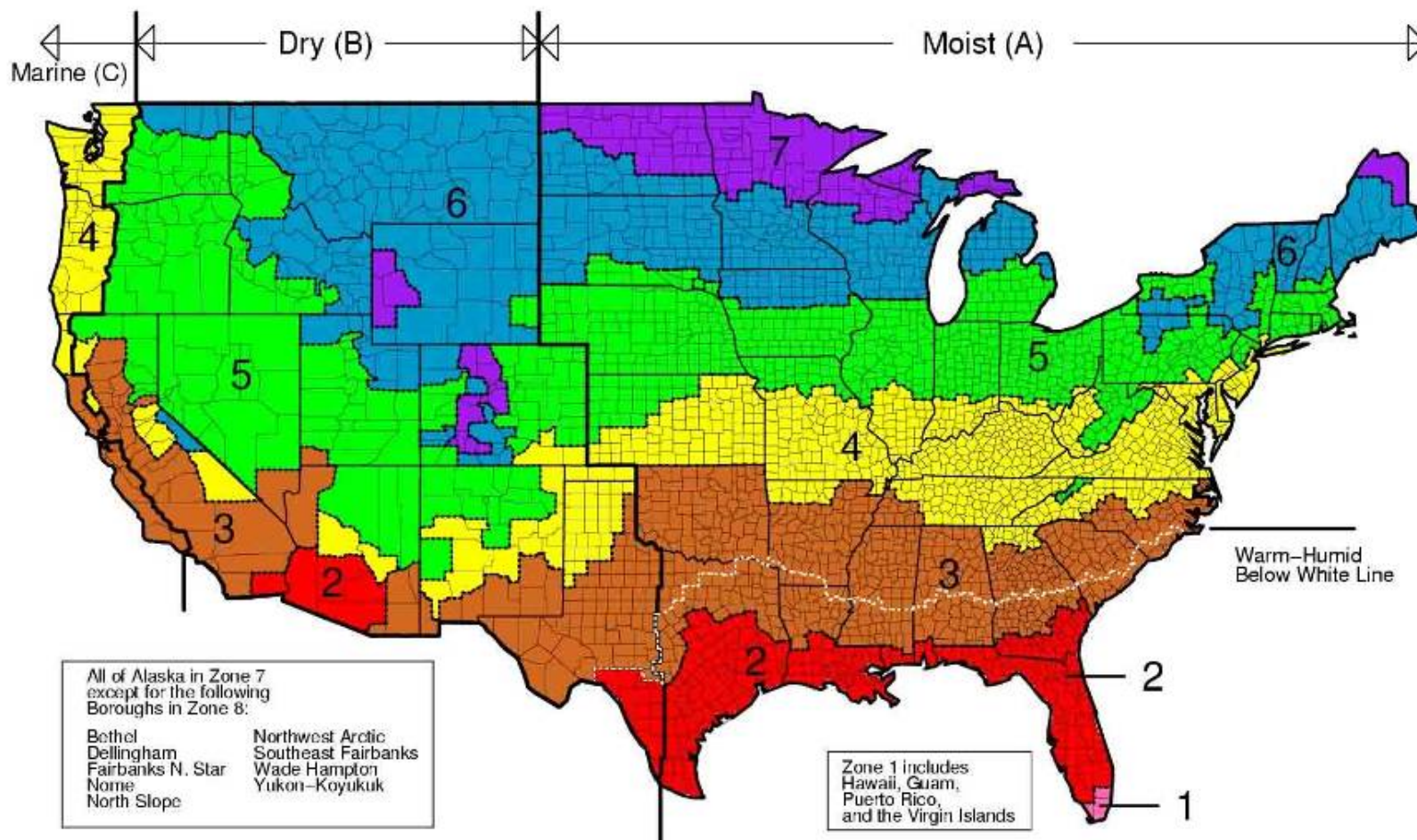

Overview of Residential Code Requirements

- ✓ Focus is on building envelope
 - Ceilings, walls, windows, floors, foundations
 - Sets insulation and fenestration levels, and solar heat gain coefficients
 - Infiltration control - caulk and seal to prevent air leaks, and test
- ✓ Ducts, air handlers, filter boxes – seal, insulate, and test
- ✓ Limited space heating, air conditioning, and water heating requirements
 - Federal law sets most equipment efficiency requirements, not the I-codes
- ✓ No appliance requirements
- ✓ Lighting equipment – 75% of lamps to be high-efficacy lamps or 75% of lighting fixtures to have only high-efficacy lamps

IECC Compliance – Three (or Four or Five) Options

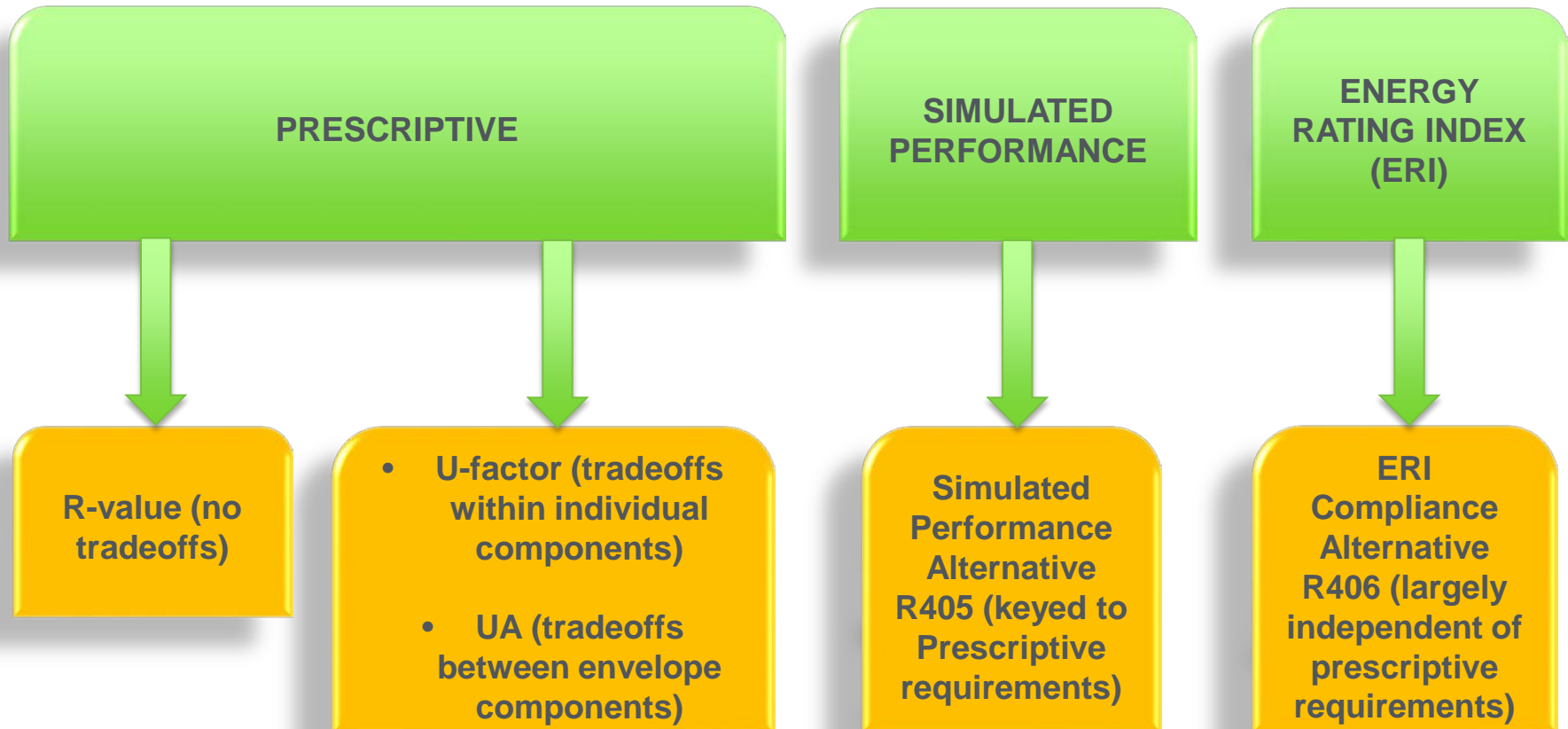

IECC Compliance – Three (or Four or Five or Six) Options

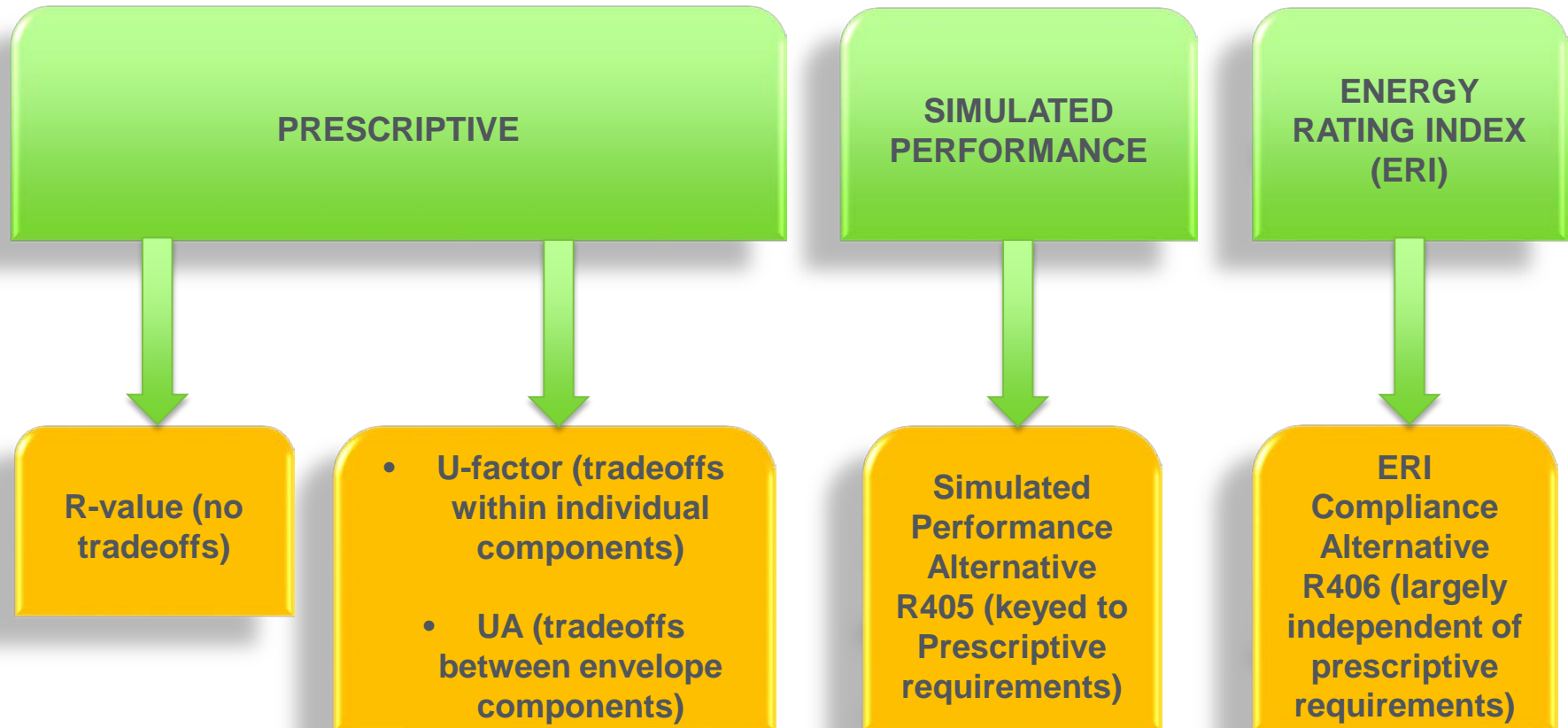

Log homes comply if envelope designed in accordance with ICC 400

Building Envelope Specific Requirements

Building Thermal Envelope consists of:

- ✓ **Fenestration**
- ✓ Ceilings
- ✓ Walls
 - Above grade
 - Below grade
 - Mass walls
- ✓ Floors
- ✓ Slabs
- ✓ Crawlspace

Exceptions:

Low energy usage

< 3.4 Btu/h/sq.ft. OR

1 watt/sq.ft. of floor area OR

unconditioned spaces OR

log homes designed in accordance with ICC 400

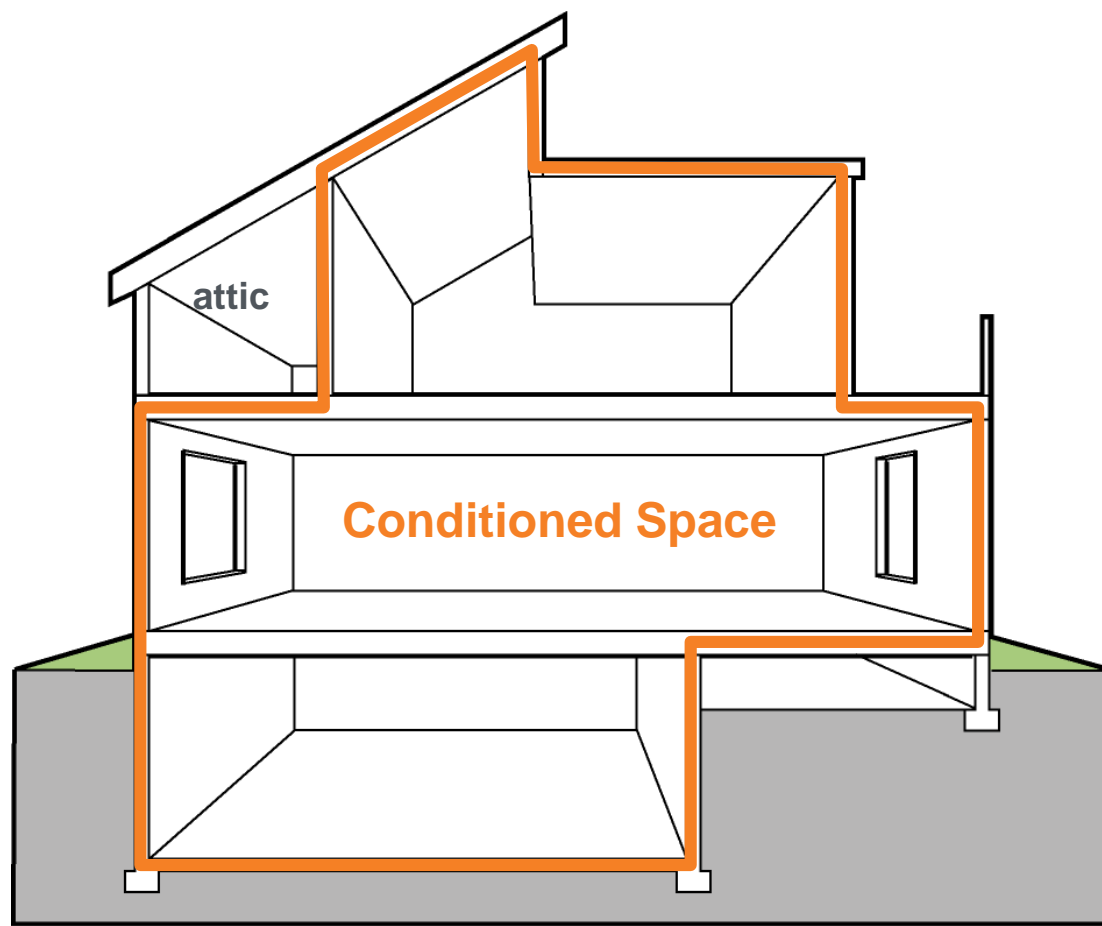

Insulation and Fenestration Requirements by Climate Zone

TABLE R402.1.2
INSULATION AND FENESTRATION REQUIREMENTS BY COMPONENT^a

CLIMATE ZONE	FENESTRATION U-FACTOR ^b	SKYLIGHT ^b U-FACTOR	GLAZED FENESTRATION SHGC ^{b,*}	CEILING R-VALUE	WOOD FRAME WALL R-VALUE	MASS WALL R-VALUE ⁱ	FLOOR R-VALUE	BASEMENT ^c WALL R-VALUE	SLAB ^d R-VALUE & DEPTH	CRAWL SPACE ^e WALL R-VALUE
1	NR	0.75	0.25	30	13	3/4	13	0	0	0
2	0.40	0.65	0.25	38	13	4/6	13	0	0	0
3	0.32	0.55	0.25	38	20 or 13+5 ^h	8/13	19	5/13 ^f	0	5/13
4 except Marine	0.32	0.55	0.40	49	20 or 13+5 ^h	8/13	19	10 /13	10, 2 ft	10/13
5 and Marine 4	0.30	0.55	NR	49	20 or 13+5 ^h	13/17	30 ^g	15/19	10, 2 ft	15/19
6	0.30	0.55	NR	49	20+5 ^h or 13+10 ^h	15/20	30 ^g	15/19	10, 4 ft	15/19
7 and 8	0.30	0.55	NR	49	20+5 ^h or 13+10 ^h	19/21	38 ^g	15/19	10, 4 ft	15/19

NR = Not Required.

For SI: 1 foot = 304.8 mm.

- R-values are minimums. U-factors and SHGC are maximums. Where insulation is installed in a cavity that is less than the label or design thickness of the insulation, the installed R-value of the insulation shall be not less than the R-value specified in the table.
- The fenestration U-factor column excludes skylights. The SHGC column applies to all glazed fenestration.
Exception: In Climate Zones 1 through 3, skylights shall be permitted to be excluded from glazed fenestration SHGC requirements provided that the SHGC for such skylights does not exceed 0.30.
- "10/13" means R-10 continuous insulation on the interior or exterior of the home or R-13 cavity insulation on the interior of the basement wall.
"15/19" means R-15 continuous insulation on the interior or exterior of the home or R-19 cavity insulation at the interior of the basement wall. Alternatively, compliance with "15/19" shall be R-13 cavity insulation on the interior of the basement wall plus R-5 continuous insulation on the interior or exterior of the home.
- R-5 insulation shall be provided under the full slab area of a heated slab in addition to the required slab edge insulation R-value for slabs, as indicated in the table. The slab edge insulation for heated slabs shall not be required to extend below the slab.
- There are no SHGC requirements in the Marine Zone.
- Basement wall insulation is not required in warm-humid locations as defined by Figure R301.1 and Table R301.1.
- Alternatively, insulation sufficient to fill the framing cavity and providing not less than an R-value of R-19.
- The first value is cavity insulation, the second value is continuous insulation. Therefore, as an example, "13+5" means R-13 cavity insulation plus R-5 continuous insulation.
- Mass walls shall be in accordance with Section R402.2.5. The second R-value applies where more than half of the insulation is on the interior of the mass wall.

- Buildings deemed to comply at elevation < 2,400 feet above sea level where the following conditions are met:
 - < ½ space is air conditioned
 - Occupied space is not heated
 - $\geq 80\%$ solar, wind, or other renewable energy source supplies service water heating
 - SHGC on fenestration ≤ 0.40 or overhang projection factor ≥ 0.30
 - Lighting in accordance with R404
 - Exterior roof complies with Table C402.2.11 (commercial cool roof) or insulation of $\geq R-15$, if present, attics above insulation are vented and attics below insulation unvented
 - Roof surface slope of not **less than ¼ unit vertical in 12 units horizontal (i.e., 1/48 or 2.1% [code says 21%])**

- Operable fenestration provides ventilation of not less than 14% of floor area for each room or equivalent ventilation is provided by a ventilation fan
- Bedrooms with 2 exterior walls facing different directions have operable fenestration
- Interior doors to bedrooms capable of being secured open
- Ceiling fan or rough-in provided for bedrooms and the largest space that is not used as a bedroom

Doors and windows

- ✓ NFRC rating or default table
 - If no labeled U-factor and SHGC, use default table
- ✓ No glass area limits
- ✓ Exemptions
 - Not greater than 15 ft² of glazing per dwelling unit (*Section R402.3.3*)
 - One side-hinged opaque door assembly not greater than 24 ft² (*Section R402.3.4*)

Skylights

Section R402.3

- ✓ Meet U-factor
- ✓ Meet SHGC



Fenestration

Sections R402.3.1/R402.3.2 - Area-weighted Average

- ✓ Can be used to satisfy U-factor and SHGC requirements
- ✓ Subject to hard limits, even in trade-offs

- ✓ Dynamic glazing
 - ✓ Ratio of higher to lower labeled SHGC ≥ 2.4
 - ✓ Automatically controlled to modulate amount of solar gain into space in multiple steps
 - ✓ Shall be considered separately from other fenestration (area weighted average)
 - ✓ Exception – not required to comply when both high and low rated SHGC meet Table R402.1.2

Building Envelope Specific Requirements

Building Envelope consists of:

- ✓ Fenestration
- ✓ **Ceilings**
- ✓ Walls
 - Above grade
 - Below grade
 - Mass walls
- ✓ Floors
- ✓ Slabs
- ✓ Crawlspace

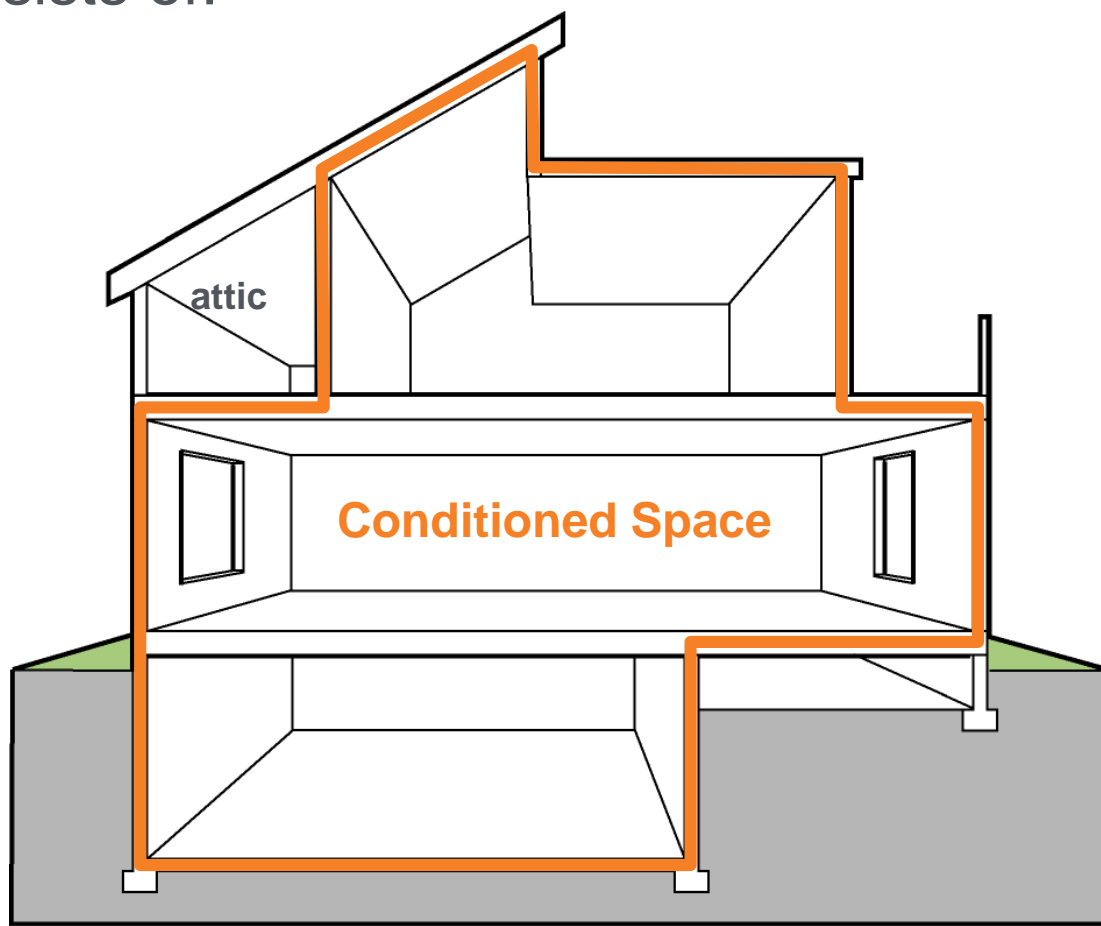

R-values are to be printed on the batt insulation or rigid foam board.

Blown-in insulation must have an insulation certificate at or near the opening of the attic.

The certificate should include:

- ✓ R-value of installed thickness
- ✓ Initial installed thickness
- ✓ Installed density
- ✓ Settled thickness/settled R-value
- ✓ Coverage area
- ✓ Number of bags installed



Insulation markers must be installed every 300 square feet and be marked with the minimum installed thickness and affixed to the trusses or joists.

Requirements based on

- ✓ Assembly type
- ✓ Continuous insulation
- ✓ Insulation between framing (cavity insulation)

Meet or exceed R-values

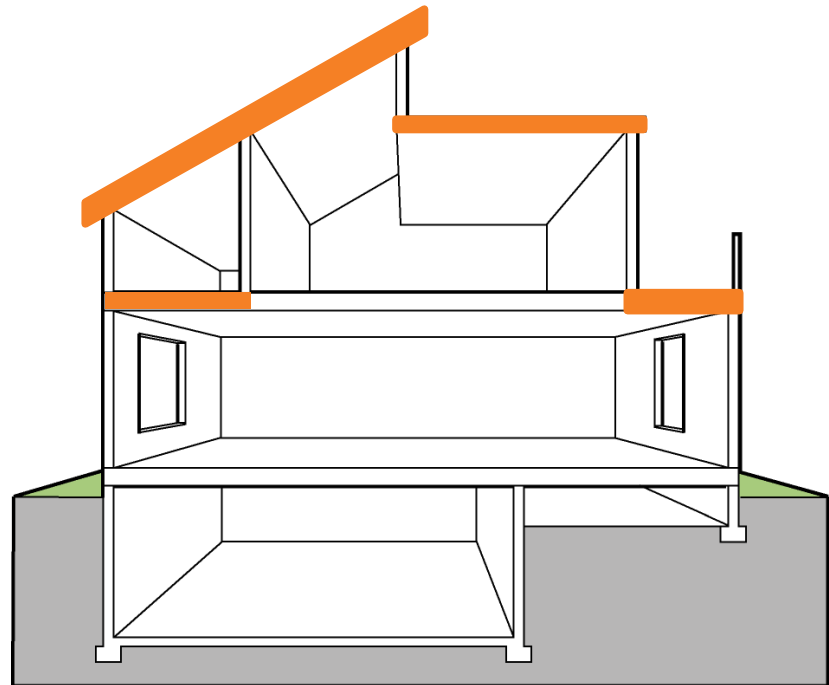

Ceilings with Attics

Section R402.2.1

Ceiling insulation requirements in R-value table assume standard truss systems

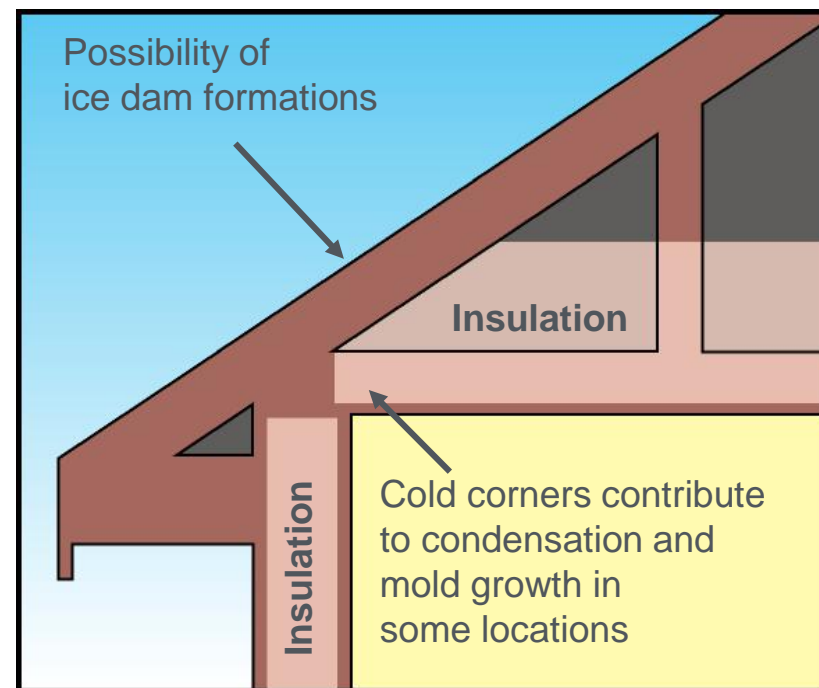

Ceilings with Attics, Cont'd.

Section R402.2.1

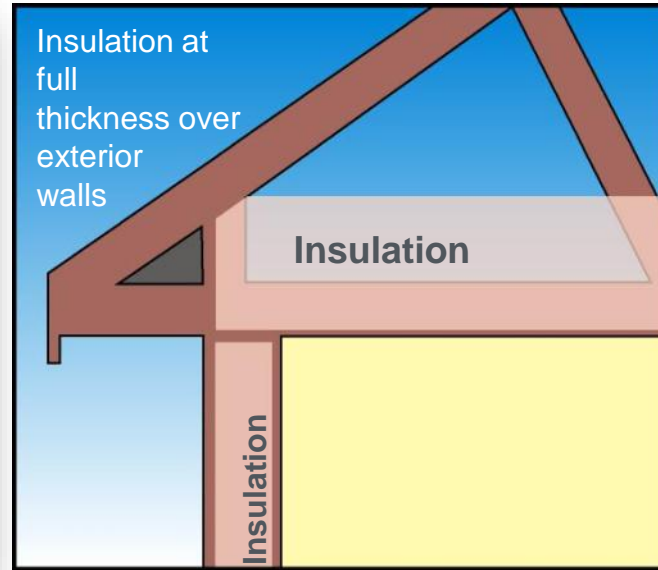

Prescriptive R-value path encourages raised heel truss (*aka, energy truss*)

- ✓ If insulation is full height uncompressed over exterior wall top plate, covering 100% of ceiling area
 - R-30 complies where R-38 is required
 - R-38 complies where R-49 is required

Note: This reduction ONLY applies to the R-value prescriptive path, not the U-factor or Total UA alternatives

Ceilings without Attic Spaces

Section R402.2.2 - (e.g., vaulted)

- ✓ If insulation is full height uncompressed over exterior wall top plate
 - ✓ R-30 allowed for up to 500 ft² or 20% total insulated ceiling area, whichever is less, where
 - ✓ Required insulation levels exceed R-30
 - ✓ Design of roof/ceiling assembly does not provide sufficient amount of space to meet higher levels

Note: This reduction ONLY applies to the R-value prescriptive path, not the U-factor or Total UA alternatives

Eave Baffle

Section R402.2.3

For air permeable insulations in vented attics, a baffle shall be installed

- ✓ Adjacent to soffit and eave vents
- ✓ To maintain an opening \geq size of vent
- ✓ To extend over top of attic insulation
- ✓ May be of any solid material

Steel-Frame Ceilings

Section R402.2.6

Table R402.2.6
Steel-Frame Ceiling, Wall and Floor Insulation
(R-Value)

Table keys on the wood-frame requirement for the corresponding building component

- ✓ “R-X + R-Y” means R-X cavity plus R-Y continuous
- ✓ In ceilings, insulation that exceeds the height of the framing must cover the framing

Wood Frame R-value Requirement	Cold-Formed Steel Equivalent R-value ^a
Steel Truss Ceilings^b	
R-30	R-38 or R-30 + 3 or R-26 + 5
R-38	R-49 or R-38 + 3
R-49	R-38 + 5
Steel Joist Ceilings^b	
R-30	R-38 in 2x4, or 2x6, or 2x8 R-49 in any framing
R-38	R-49 2x4, or 2x6, or 2x8, or 2x10
Steel Framed Wall, 16 inches on center	
R-13	R-13 + 4.2 or R-21 + 2.8, or R-0+9.3 or R-15+R-3.8 or R-21 + 3.1
R-13+3	R-0 + 11.2 or R-13 + 6.1, or R-15 + 5.7 or R-19+5.0 or R-21+4.7

Access Hatches and Doors

Section R402.2.4 - Prescriptive

Weatherstrip and insulate doors from conditioned spaces to unconditioned spaces (*e.g., attics and crawl spaces*)

- ✓ Insulate to level equivalent to surrounding surfaces
 - *e.g.*, required ceiling insulation = R-38, then attic hatch must be insulated to R-38

Provide access to all equipment that prevents damaging or compressing the insulation

Install a wood framed or equivalent baffle or retainer when loose fill insulation is installed

Exception:

Vertical doors that provide access can meet

Table R402.1.2

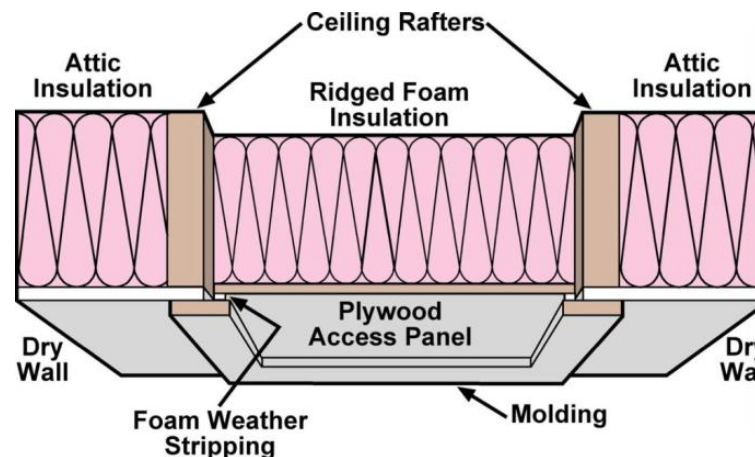

Building Envelope Specific Requirements

Building Envelope consists of:

- ✓ Fenestration
- ✓ Ceilings
- ✓ **Walls**
 - Above grade
 - Below grade
 - Mass walls
- ✓ Fenestration
- ✓ Floors
- ✓ Slabs
- ✓ Crawlspace

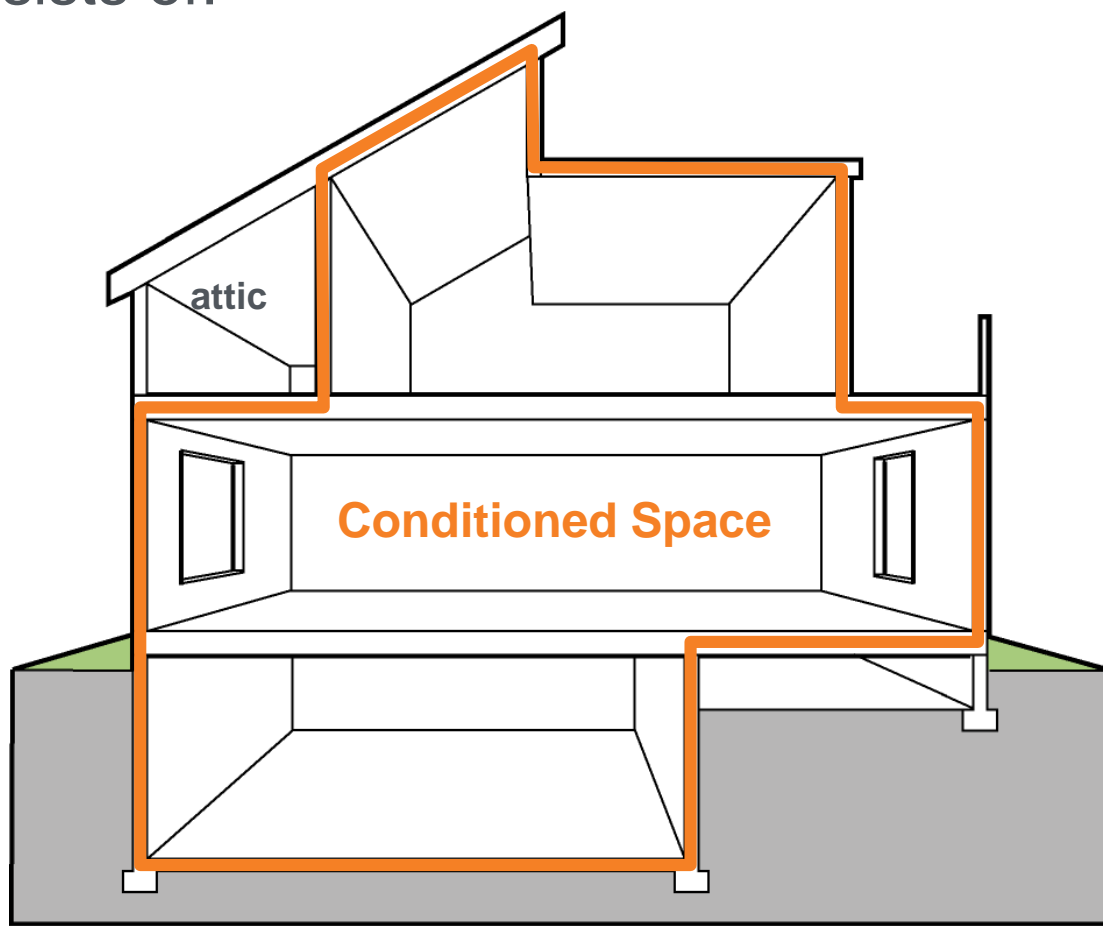

- ✓ Exterior above-grade walls
- ✓ Attic kneewalls
- ✓ Skylight shaft walls
- ✓ Perimeter joists
- ✓ Basement walls
- ✓ Garage walls (*shared with conditioned space*)

Above Grade Walls

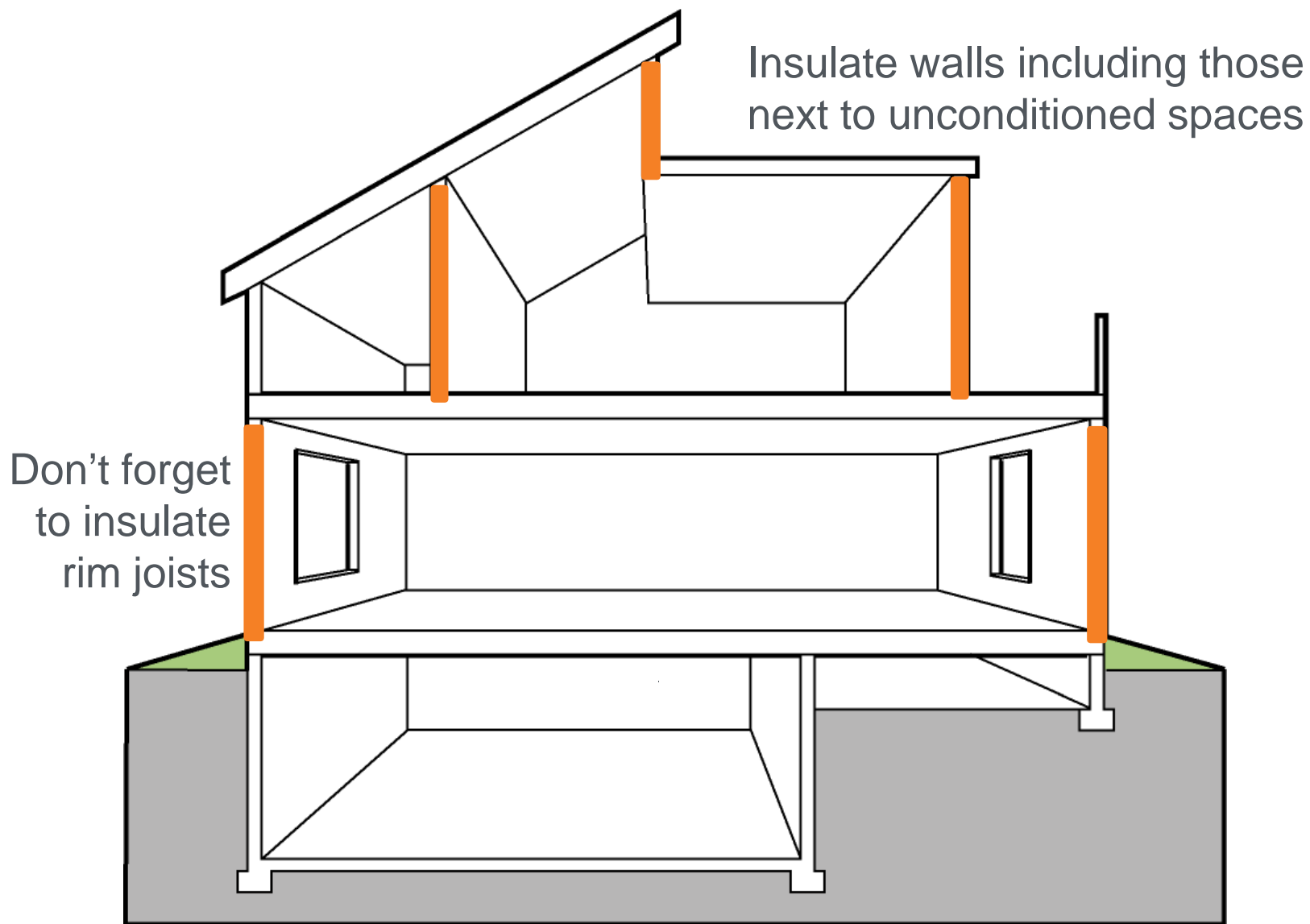

Table R402.1.2
INSULATION AND FENESTRATION REQUIREMENTS BY COMPONENT

CLIMATE ZONE	...	WOOD FRAME WALL R-VALUE
1		13
2		13
3		20 or 13+5 ^h
4 except Marine		20 or 13+5 ^h
5 and Marine 4		20 or 13+5 ^h
6		20+5 or 13+10 ^h
7 and 8		20+5 or 13+10 ^h

h. First value is cavity insulation, second is continuous insulation so. Therefore, as an example, “13+5” means R-13 cavity insulation plus R-5 continuous insulation

Walls – Insulated Siding

Section R303.1

- R-value labeled on product package
- **Indicated** on certification
- Installer signature and date
- Posted on site in conspicuous location
- Thermal resistance (R-value) determined in accordance with ASTM C 1363

Steel-Frame Walls

Section R402.2.6

Table R402.2.6
Steel-Frame Ceiling, Wall and Floor Insulation
(R-Value)

Wood Frame R-value Requirement	Cold-Formed Steel Equivalent R-value ^a
	Steel Truss Ceilings ^b
R-30	R-38 or R-30 +
R-38	R-49 or R-38 +
R-49	R-38 + 5
	Joist Ceilings ^b
	R-38 in 2x4, or
	R-49 any fram
	R-49 2x4, or 2
	Steel Framed Wall
R-13	R-13 + 4.2 or R-19 + 2.1, or R-21 + 2.8 or R-0+9.3 or R-15+R-3.8 or R-21 + 3.1
R-13+R-3	R-0 + 11.2 or R-13 + 6.1, or R-15 + 5.7 or R-19+5.0 or R-21+4.7

Table keys on the wood-frame requirement for the corresponding building component

✓ “R-X + R-Y” means R-X cavity plus R-Y continuous

Mass Walls

Section R402.2.5

What type

- ✓ Concrete block, concrete, insulated concrete form (ICF), masonry cavity, brick (other than brick veneer), **adobe**, **compressed earth block**, **rammed earth**, and solid timber/logs
- ✓ Any other walls having a heat capacity ≥ 6 Btu/ft.²/°F

Provisions

- ✓ Are assumed to be above grade walls



Mass Wall Requirements

Section R402.2.5

Table R402.1.2
INSULATION AND FENESTRATION REQUIREMENTS BY COMPONENT

CLIMATE ZONE	...	MASS WALL R-VALUE ⁱ
1		3/4
2		4/6
3		8/13
4 except Marine		8/13
5 and Marine 4		13/17
6		15/20
7 and 8		19/21

Second (higher) number applies when more than half the R-value is on the interior of the mass (i.e., when the thermal mass is insulated from the conditioned space)

Walls with Partial Structural Sheathing

Section R402.2.7

If structural sheathing covers $\leq 40\%$ of gross wall area

The continuous insulation R-value can be reduced by as much as R-3 if necessary to result in a consistent total sheathing thickness on areas of walls covered by structural sheathing

This reduction does not apply to the U-factor alternative or Total UA alternative

Building Envelope Specific Requirements

Building Envelope consists of:

- ✓ Fenestration
- ✓ Ceilings
- ✓ Walls
 - Above grade
 - Below grade
 - Mass walls
- ✓ **Floors**
- ✓ Slabs
- ✓ Crawlspace

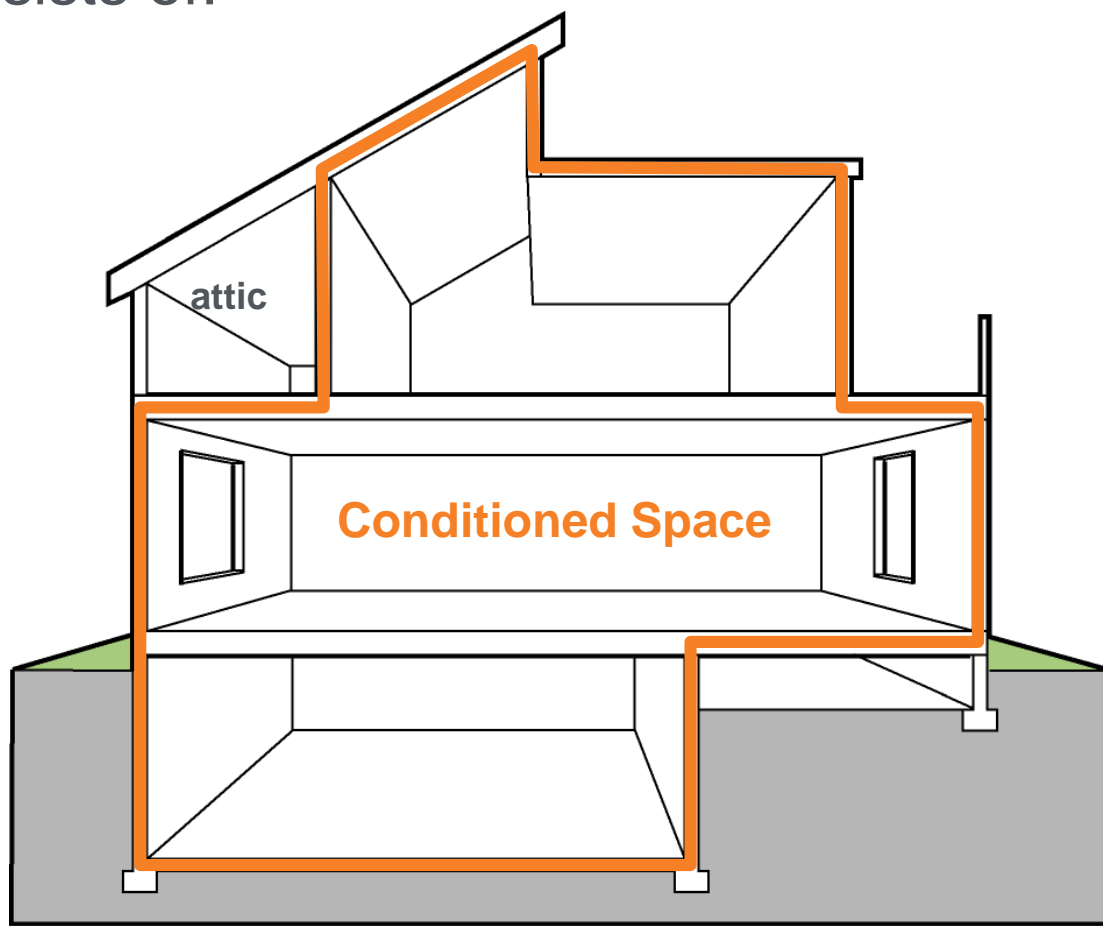

Floors Over Unconditioned Space

Section R402.2.8

Table R402.1.2
INSULATION AND FENESTRATION REQUIREMENTS BY COMPONENT

CLIMATE ZONE	...	FLOOR R-VALUE
1		13
2		13
3		19
4 except Marine		19
		30 ^g
		30 ^g
		38 ^g

Exception: If framing members are too small to accommodate R-30, insulation that fills the framing cavity, not less than R-19, complies

Floors (Over Unconditioned Space)

Section 402.2.8

Unconditioned space includes unheated basement, vented crawlspace, or outdoor air

Climate Zones	R-Value
1-2	13
3-4ab	19
4c-6	30*
7-8	38*

Exception: cavity insulation in contact with the topside of sheathing or continuous insulation installed on the bottom of floor framing where combined with insulation that meets or exceeds Table R402.1.2 requirements for wood frame walls and that extends from bottom to the top of all perimeter floor framing members



Insulation must maintain permanent contact with underside of subfloor

* **Exception**

Climate Zones 4c-8

R-19 permitted if cavity completely filled

Table R402.2.6
Steel-Frame Ceiling, Wall and Floor Insulation
(R-Value)

Wood Frame R-value Requirement	Cold-Formed Steel-Frame Equivalent R-value ^a
Steel Joist Floor ^b	
R-13	R-19 in 2x6, or R-19 + 6 in 2x8 or 2x10
R-19	R-19 + 6 in 2x6, or R-19 + 12 in 2x8 or 2x10

Table keys on the wood-frame requirement for the corresponding building component

✓ “R-X + R-Y”
means R-X
cavity plus R-Y
continuous

Defining Below-Grade Walls

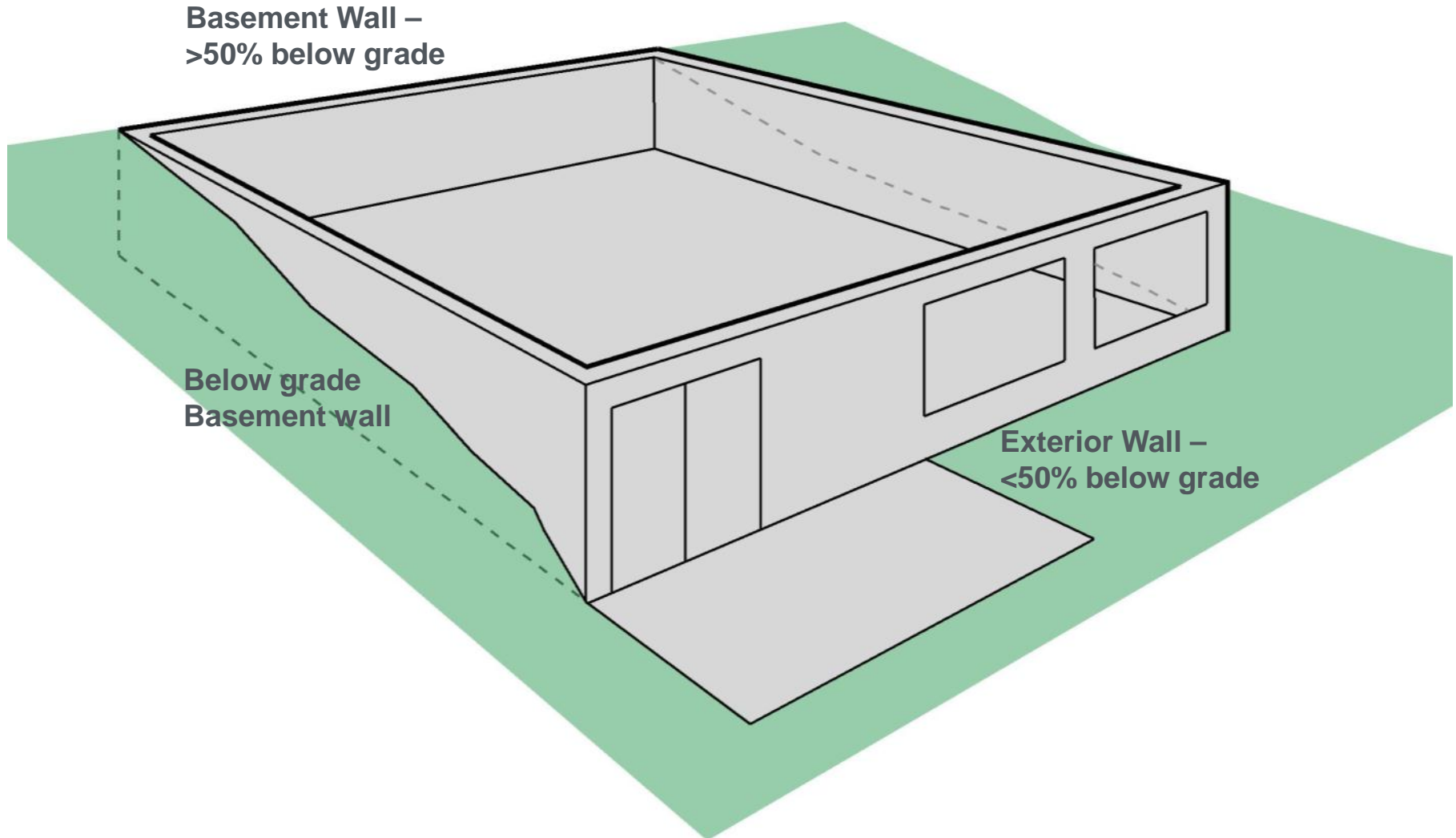

Below-Grade Walls

- ✓ $\geq 50\%$ below grade
- ✓ Otherwise treat as above-grade wall

Climate Zones	R-Value
1-2	0
3	5/13
4ab	10/13
4c-8	15/19

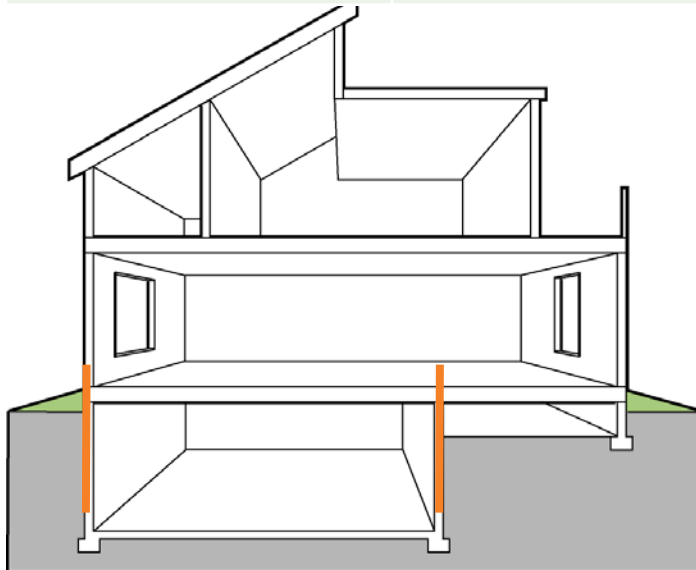

Insulated from top of basement wall down to 10 ft below grade or basement floor, whichever is less

Table R402.1.2
INSULATION AND FENESTRATION REQUIREMENTS BY COMPONENT

CLIMATE ZONE	...	FLOOR R-VALUE	BASEMENT ^c WALL R-VALUE
1		13	0
2		13	0
3		19	5/13 ^f
4 except			10/13
			15/19
			15/19
			15/19

- “X/Y” means R-X continuous or R-Y cavity
- 15/19 requirement can be met with R-13 cavity (interior) plus R-5 continuous (exterior)
- In zone 3, no insulation required in warm-humid counties (footnote f)

Building Envelope Specific Requirements

Building Envelope consists of:

- ✓ Fenestration
- ✓ Ceilings
- ✓ Walls
 - Above grade
 - Below grade
 - Mass walls
- ✓ Floors
- ✓ **Slabs**
- ✓ Crawlspace

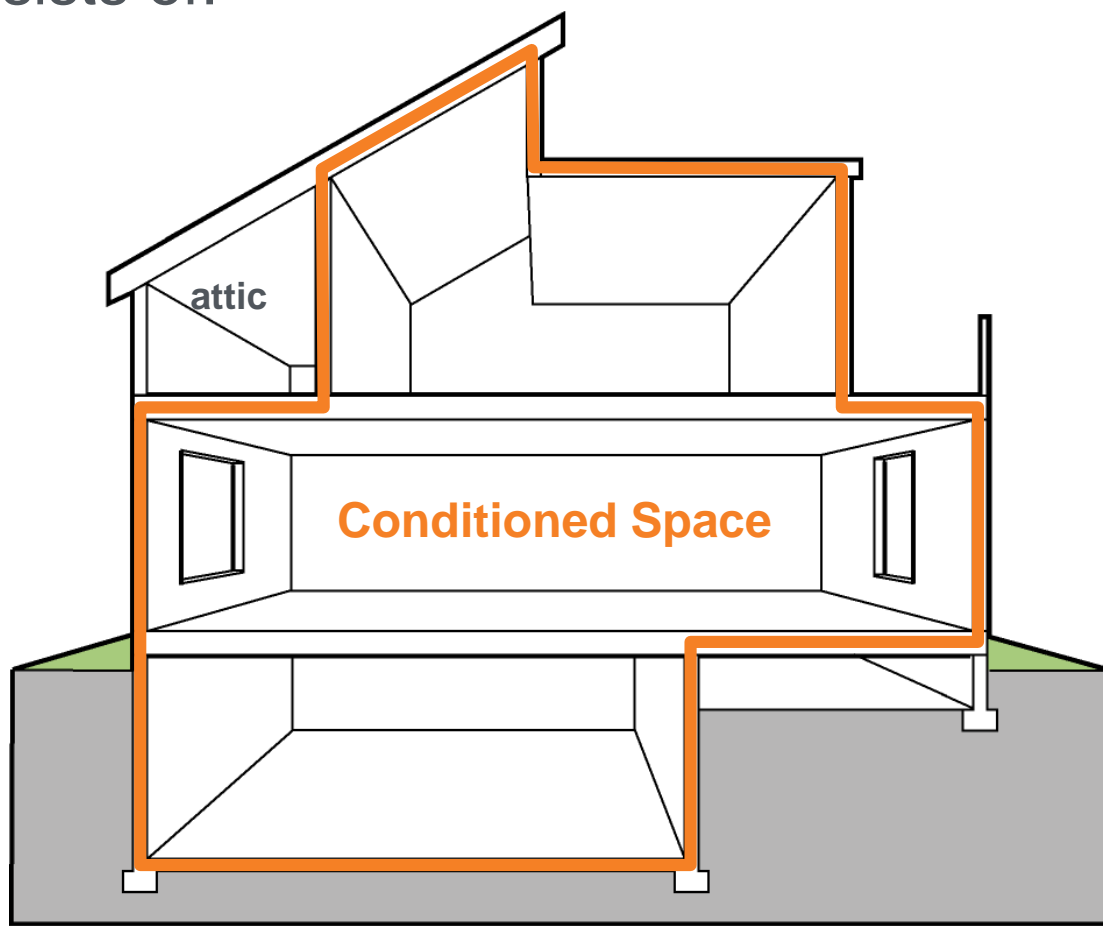

Slab Edge Insulation

Section R402.2.10

Applies to slabs with a floor surface < 12 inches below grade

- ✓ R-10 (typically 2 inches) insulation in Zones 4 and above
- ✓ Must extend downward from top of slab a minimum of 24" (Zones 4 and 5) or 48" (Zones 6, 7, and 8)
- ✓ Insulation can be vertical or extend horizontally under the slab or out from the building
- ✓ Insulation extending outward must be under 10 inches of soil or pavement
 - An additional R-5 is required for heated slabs
 - Insulation to depth of the footing or 2 feet, whichever is less in Zones 1-3 for heated slabs

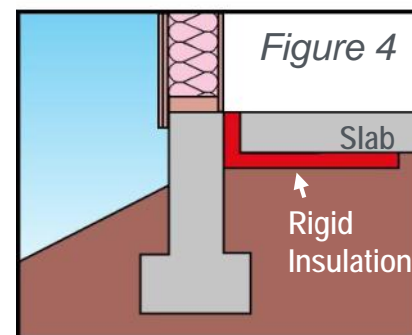
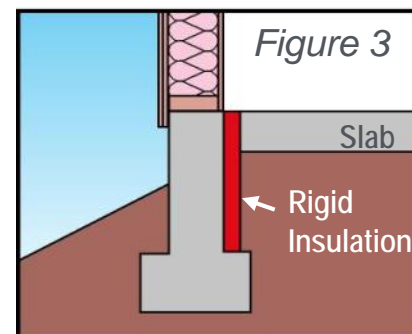
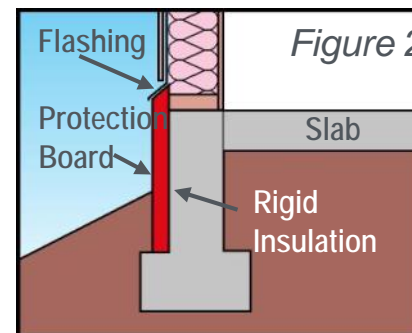

Slab Edge Insulation

Section R402.2.10

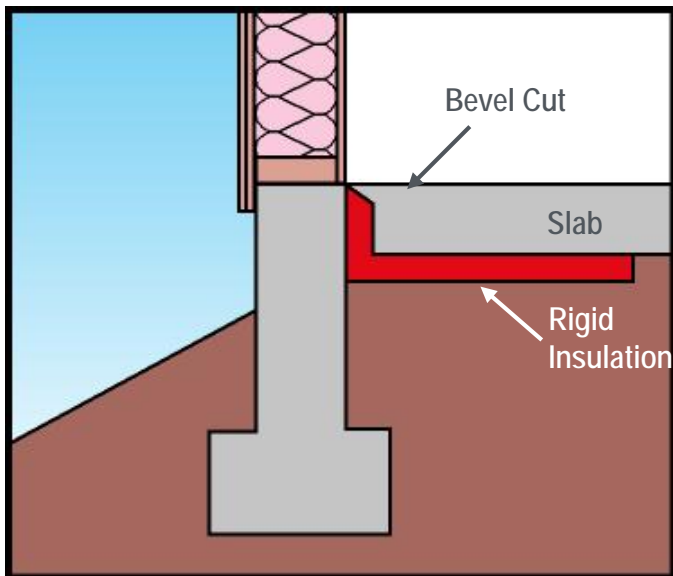

Building Envelope Specific Requirements

Building Envelope consists of:

- ✓ Fenestration
- ✓ Ceilings
- ✓ Walls
 - Above grade
 - Below grade
 - Mass walls
- ✓ Floors
- ✓ Slabs
- ✓ **Crawlspaces**

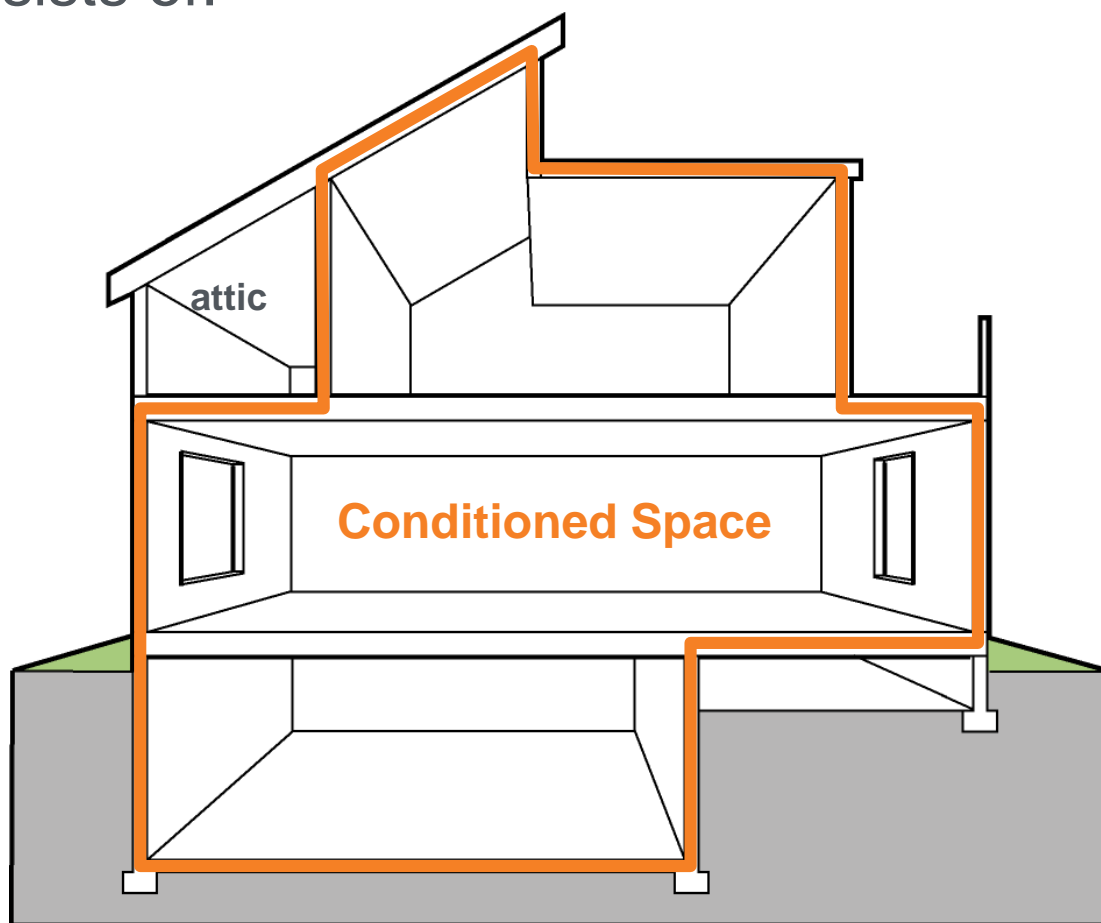

Crawlspace Wall Insulation

Section R402.2.11

Implies an unvented crawlspace (*aka, conditioned crawlspace*)

- ✓ Space must be mechanically vented or receive minimal supply air (*Refer to IRC*)
- ✓ Exposed earth must be covered with a continuous Class I vapor retarder

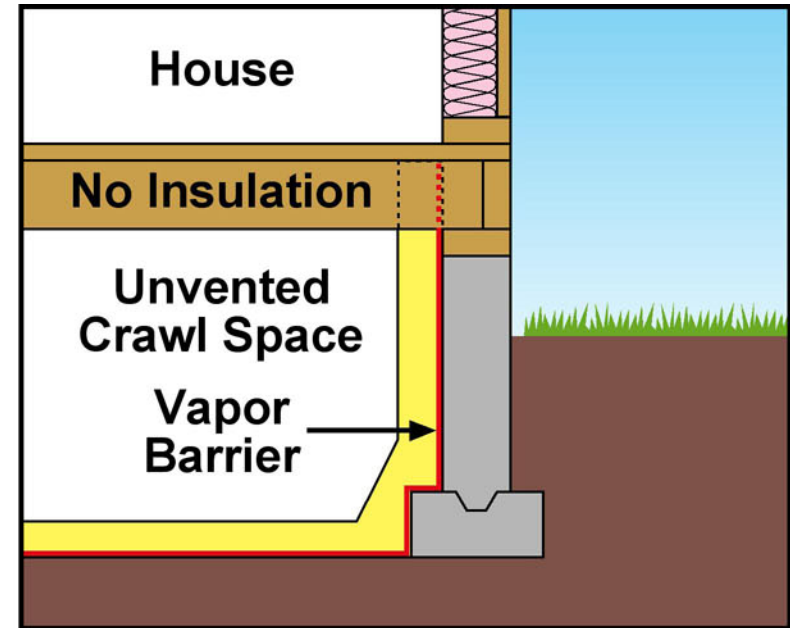
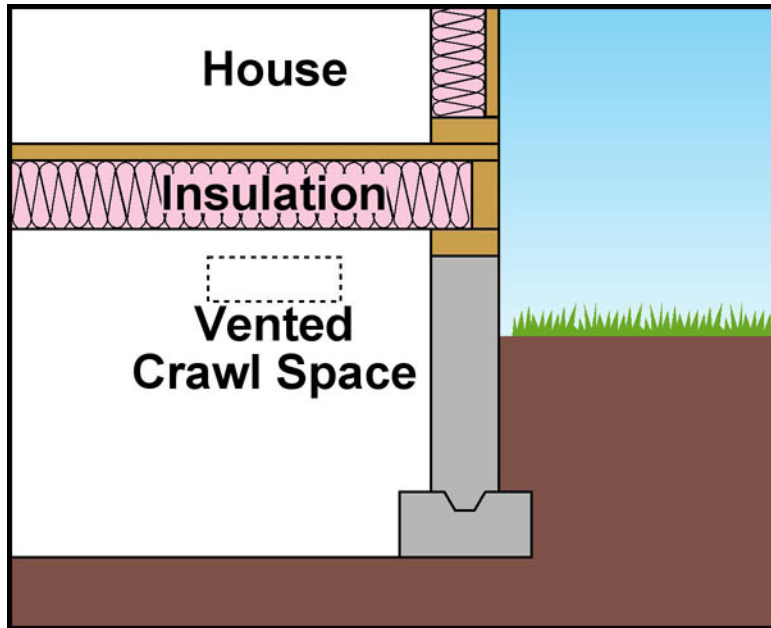

Vented Crawlspace Requirements:

- ✓ The raised floor over the crawlspace must be insulated.
- ✓ A vapor retarder may be required as part of the floor assembly.
- ✓ Ventilation openings must exist that are equal to at least 1 square foot for each 150 square feet of crawlspace area and be placed to provide cross-flow (*IRC 408.1, may be less if ground vapor retarder is installed*).
- ✓ Ducts in crawlspace must be sealed and have R-6 insulation.

Unvented Crawlspace Requirements:

- ✓ The crawlspace ground surface must be covered with an approved vapor retarder (*e.g., plastic sheeting*).
- ✓ Crawlspace walls must be insulated to the R-value requirements specific for crawlspace walls (*IECC Table R402.1.2*).
- ✓ Crawlspace wall insulation must extend from the top of the wall to the inside finished grade and then 24" vertically or horizontally.
- ✓ Crawlspace must be mechanically vented (*1 cfm exhaust per 50 square feet*) or conditioned (*heated and cooled as part of the building envelope*).
- ✓ Ducts are inside conditioned space and therefore don't need to be insulated.

U-factor Alternative

- ✓ Similar to Prescriptive R-Value but uses U-factors instead
 - Allows for innovative or less common construction techniques such as structural insulated panels or advanced framing
 - Allows no trade-offs between building components

Total UA Alternative

- ✓ Also uses U-factors in lieu of R-values, but allows trade-offs across all envelope components
 - Primary approach used in REScheck software
 - UA – U-factor x area of assembly

Requirements by Climate Zone

U-Factor Table

TABLE R402.1.4
EQUIVALENT U-FACTORS^a

CLIMATE ZONE	FENESTRATION U-FACTOR	SKYLIGHT U-FACTOR	CEILING U-FACTOR	FRAME WALL U-FACTOR	MASS WALL U-FACTOR ^b	FLOOR U-FACTOR	BASEMENT WALL U-FACTOR	CRAWL SPACE WALL U-FACTOR
1	0.50	0.75	0.035	0.084	0.197	0.064	0.360	0.477
2	0.40	0.65	0.030	0.084	0.165	0.064	0.360	0.477
3	0.32	0.55	0.030	0.060	0.098	0.047	0.091 ^c	0.136
4 except Marine	0.32	0.55	0.026	0.060	0.098	0.047	0.059	0.065
5 and Marine 4	0.30	0.55	0.026	0.060	0.082	0.033	0.050	0.055
6	0.30	0.55	0.026	0.045	0.060	0.033	0.050	0.055
7 and 8	0.30	0.55	0.026	0.045	0.057	0.028	0.050	0.055

a. Nonfenestration U-factors shall be obtained from measurement, calculation or an approved source.

b. Mass walls shall be in accordance with Section R402.2.5. Where more than half the insulation is on the interior, the mass wall U-factors shall not exceed 0.17 in Climate Zone 1, 0.14 in Climate Zone 2, 0.12 in Climate Zone 3, 0.087 in Climate Zone 4 except Marine, 0.065 in Climate Zone 5 and Marine 4, and 0.057 in Climate Zones 6 through 8.

c. In warm-humid locations as defined by Figure R301.1 and Table R301.1, the basement wall U-factor shall not exceed 0.360.

Provisions

- ✓ Apply when wall heat capacity ≥ 6 Btu/ft²/°F
- ✓ When more than half the insulation is on the interior, the mass wall U-factors

Climate Zones	U-Factor Maximum
1	0.197 / 0.170
2	0.165 / 0.140
3	0.098 / 0.120
4 except Marine	0.098 / 0.087
4 Marine and 5	0.082 / 0.065
6	0.060 / 0.057
7 and 8	0.057 / 0.057

Hard limits on U-factor in northern U.S. (cannot be exceeded, even in trade-offs or ERI path)

Climate Zones	U-Factor Maximum
4-5	0.48
6-8	0.40

- ✓ U-0.75 for skylights in **Zones 4-8**
- ✓ U-factors of individual windows or skylights can be higher if area-weighted average is below these limits.

Hard limit on Solar Heat Gain Coefficient in southern U.S. (Zones 1-3)

- ✓ SHGC cannot exceed 0.50, even in performance trade-offs or ERI path
- ✓ SHGCs of individual windows or skylights can be higher if area-weighted average is below this limit.

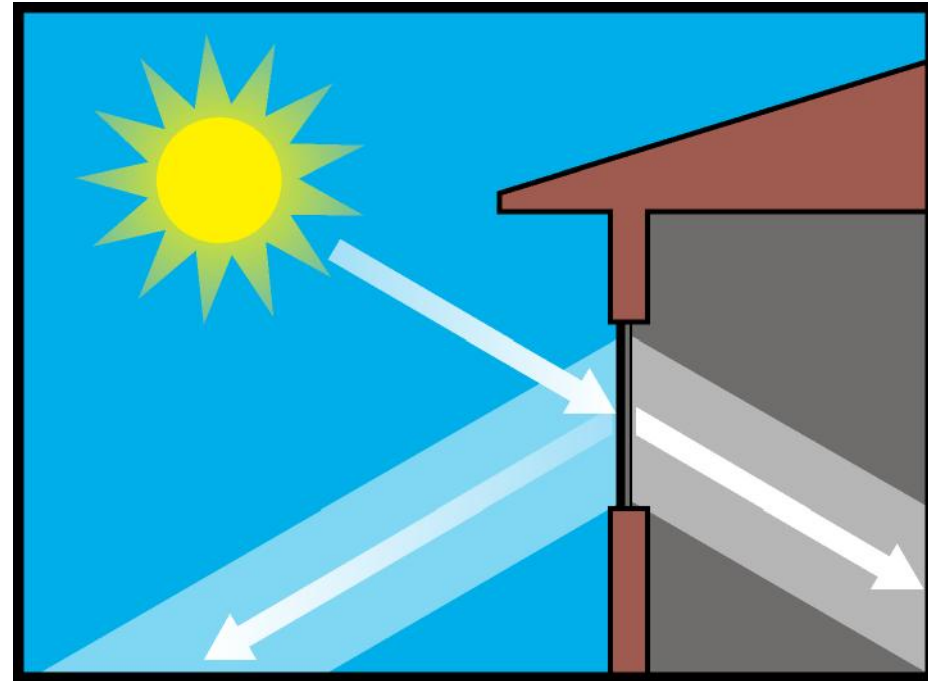

Solar Heat Gain Coefficient

Less stringent insulation
R-value and glazing
U-factor requirements

Sunroom definition:

- ✓ One story structure
- ✓ Glazing area >40% glazing of gross exterior wall and roof area
- ✓ Separate heating or cooling system or zone
- ✓ Must be thermally isolated (both HVAC and physical separation—closeable doors or windows between sunroom and rest of the house)
- ✓ Can always meet Table R402.1.2 requirements with unlimited glass



Sunroom Requirements

Section R402.2.13

- ✓ Ceiling Insulation
 - Zones 1-4 R-19
 - Zones 5-8 R-24
- ✓ Wall Insulation
 - All zones R-13
- ✓ Fenestration U-Factor
 - Zones 2-8 0.45
- ✓ Skylight U-Factor
 - Zones 2-8 0.70

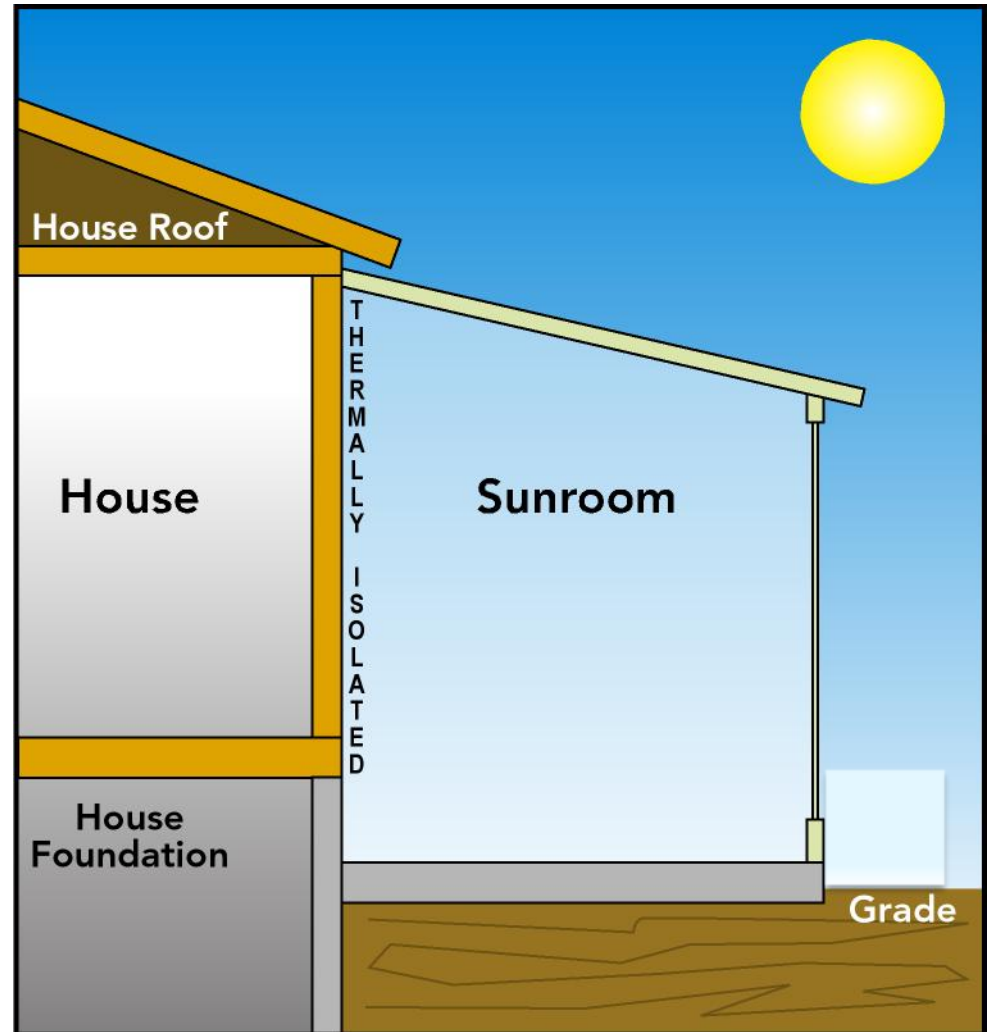

- Proposed design to be shown to have an annual energy cost that is less than or equal to the annual energy cost of the standard reference design
- Specifications for standard reference and proposed design are in Table R504.5.2(1)
 - **New in 2018: Allowance for batch sampling of stacked multifamily units**

- ✓ Requires computer software with specified capabilities (local official may approve other tools)
- ✓ Includes both envelope and some systems
 - Equipment treated equally in standard and proposed design
- ✓ Allows greatest flexibility
 - Can trade off tight duct systems
- ✓ Defines compliance based on equivalency of calculated energy cost or source energy
- ✓ Section R405 specifies “ground rules”
 - These will generally be “hidden” in compliance software calculation algorithms
 - Similar ground rules are used in home federal tax credits and ENERGY STAR Home guidelines

- First included in the 2015 IECC, ERI path differs from the traditional prescriptive and performance paths
 - Unlike the performance path, is not based on the prescriptive requirements
 - Fundamental requirement is a single rating (ERI) based on **ANSI/RESNET/ICC 301-2014**
- Mandatory provisions of the code must be met
 - Exception: Ducts not completely inside the building thermal envelope must be insulated to R-6 or greater
- Hard limit: Envelope must meet minimum requirements of the 2009 IECC

Energy Rating Index (Compliance Alternative)

Section R406

- Compliance with this method must be completed by an approved third party and documentation including compliance reports must be reviewed by the code official
- Compliance is demonstrated if the calculated ERI is \leq a defined threshold for the zone in which the building is located

Table R406.4
Maximum Energy Rating Index

Climate Zone	ERI ^a
1	57
2	57
3	57
4	62
5	61
6	61
7	58
8	58

- ERI is determined in accordance with ANSI/RESNET/ICC 301-2014
- Except for buildings covered by IRC, the ERI Reference Design Ventilation rate is changed from 301's spec:

Equation 4-1

Ventilation rate, CFM = (0.01 x total square foot area of house) + [7.5 x (number of bedrooms + 1)]

Energy used to recharge or refuel a vehicle used for transportation on roads not on the building site not included in ERI reference design or rated design

Mandatory Requirements

Section R402.4 - Air Leakage

- ✓ Building thermal envelope (Section R402.4.1)
- ✓ Recessed lighting
- ✓ Fenestration
- ✓ Fireplaces
- ✓ Rooms with fuel burning appliances

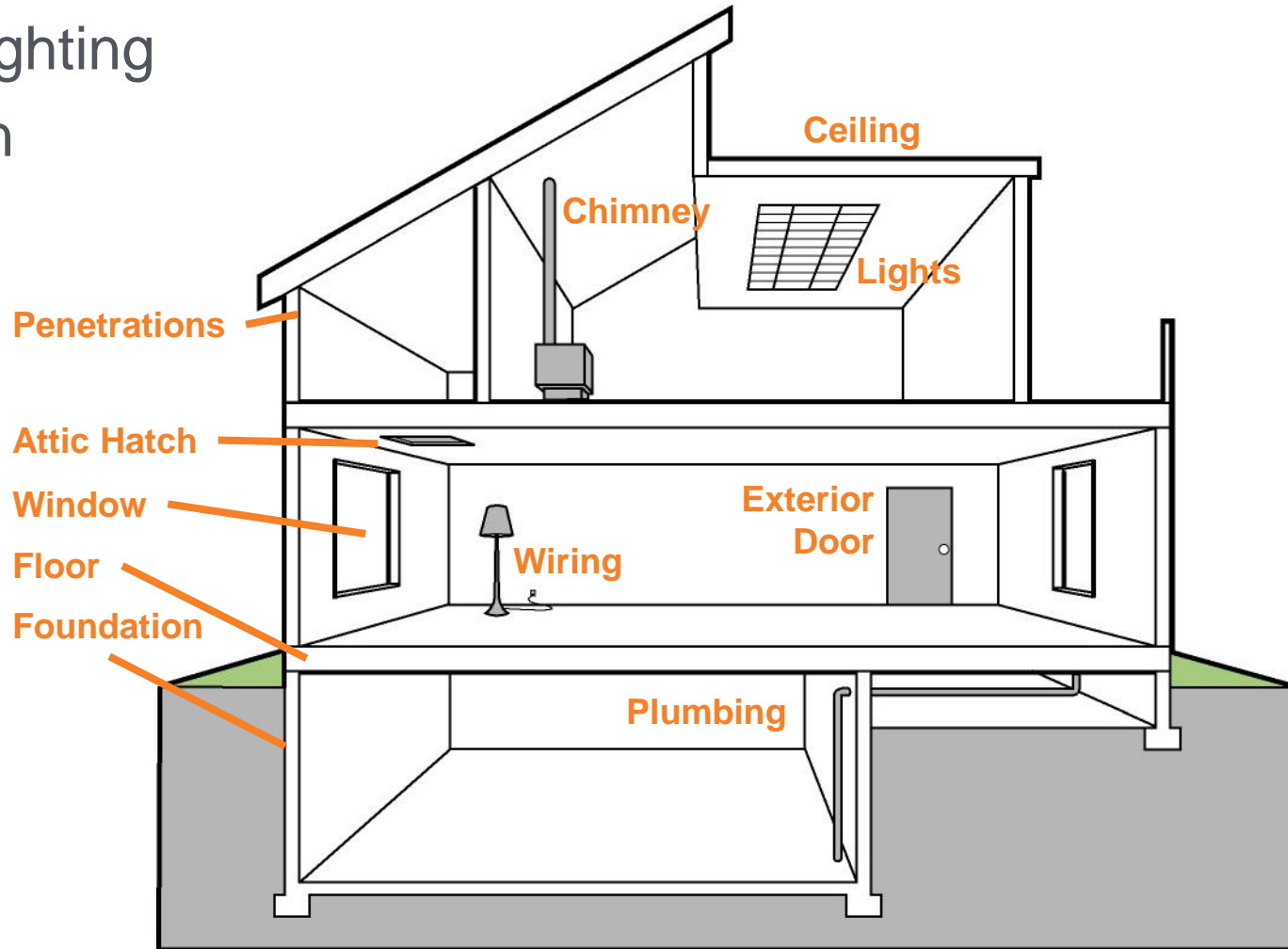

Air Leakage Control

Section R402.4.1

Building thermal envelope



Requires BOTH:

- ✓ Whole-house pressure test

Air Leakage Rate	Climate Zone	Test Pressure
≤ 5 ACH	1-2	50 Pascals
≤ 3 ACH	3-8	50 Pascals

- Testing may occur any time after creation of all building envelope penetrations
- ✓ Field verification of items listed in Table R402.5.1.1

Table R402.4.1.1

Component	Air Barrier Criteria	Insulation Installation Criteria
General requirements	<p>A continuous air barrier shall be installed in the building envelope.</p> <p>The exterior thermal envelope contains a continuous air barrier.</p> <p>Breaks or joints in the air barrier shall be sealed.</p>	<p>Air-permeable insulation shall not be used as a sealing material.</p>
Ceiling/attic	<p>The air barrier in any dropped ceiling or soffit shall be aligned with the insulation and any gaps in the air barrier sealed.</p> <p>Access openings, drop down stair or knee wall doors to unconditioned attic spaces shall be sealed.</p>	<p>The insulation in any dropped ceiling/soffit shall be aligned with the air barrier.</p>
Walls	<p>The junction of the foundation and sill plate shall be sealed.</p> <p>The junction of the top plate and the top of exterior walls shall be sealed.</p> <p>Knee walls shall be sealed.</p>	<p>Cavities within corners and headers of frame walls shall be insulated by completely filling the cavity with a material having a thermal resistance R-value of not less than R-3 per inch.</p> <p>Exterior thermal envelope insulation for framed walls shall be installed in substantial contact and continuous alignment with the air barrier.</p>
Windows, skylights and doors	<p>The space between framing and skylights and the jambs of windows and doors shall be sealed.</p>	

(partial table)

Fireplaces

Section R402.4.2

- New wood-burning fireplaces shall have tight fitting flue dampers or doors, and outdoor combustion air
- Tight fitting doors on fireplaces that are:
 - Factory built – listed and labeled per UL 127



Fenestration Air Leakage

Section R402.4.3

TYPE	AIR INFILTRATION RATE
Windows, sliding glass doors, and skylights	≤ 0.3 cfm/ft ²
Swinging doors	≤ 0.5 cfm/ft ²

Exceptions

- ✓ Site-built windows, skylights, and doors

Rooms with fuel burning appliances

Section R402.4.4

- Climate Zones 3-8
- Open combustion fuel burning appliances where open combustion air ducts provide combustion air
 - The appliances and combustion air opening shall be located outside the building thermal envelope OR
 - Enclosed in a room isolated from inside the thermal envelope
 - Sealed and insulated per Table R402.1.2
 - Door gasketed and sealed
 - Any ducts or water lines insulated per R403
 - Combustion air duct insulated to an R-value of not less than R-8 where it passes through conditioned space
 - Exceptions:
 - Direct vent appliances with both intake and exhaust pipes installed continuous to outside
 - Fireplaces and stoves complying with R402.4.2 and Section R1006-IRC

Recessed Lighting Fixtures

Section R402.4.5

- ✓ Type IC rated and labeled as meeting ASTM E 283 when tested at 1.57 psf (75 Pa) pressure differential with no more than 2.0 cfm of air movement
- ✓ Sealed with a gasket or caulk between the housing and interior wall or ceiling covering



Equipment efficiency set by Federal law, not the
I-Codes

Requirements for Systems

Section R403

- ✓ Controls
- ✓ Heat pump supplementary heat
- ✓ Hot water boiler outdoor temperature setback
- ✓ Ducts
 - Sealing (Mandatory)
 - Insulation (Prescriptive)
- ✓ HVAC piping insulation
- ✓ Hot water systems
- ✓ Ventilation
 - Dampers
- ✓ Equipment sizing
- ✓ Systems serving multiple dwelling units
- ✓ Snow melt controls
- ✓ Pools and in-ground permanently installed spas

Programmable Thermostat

Section R403.1.1 - Controls

- ✓ At least one programmable thermostat controlling the primary heating/cooling per dwelling unit
- ✓ Capability to set back or temporarily operate the system to maintain zone temperatures
 - Not less than 55°F (13°C) or
 - Not greater than 85°F (29°C)
- ✓ Initially programmed by manufacturer with:
 - heating temperature set point not greater than 70°F (21°C) and
 - cooling temperature set point not less than 78°F (26°C)



Prevent supplementary electric-resistance heat when heat pump can meet the heating load

Exception

- ✓ During defrost

Hot Water Boiler Outdoor Temp. Setback

Section R403.2

- One- or two-pipe heating systems must have an outdoor setback control to decrease boiler temperature based on outdoor temperature

Duct Insulation

Section R403.3.1 - Prescriptive

- ✓ Supply and return ducts in **attics**: R-8 where $\geq 3''$ diameter, R-6 if $< 3''$
- ✓ Other areas: R-6 where $\geq 3''$ diameter, R-4.2 if $< 3''$

Examples

Location	Duct Diameter $\geq 3''$ or $< 3''$
Attic	R-8 or R-6
Conditioned Space	NR
Vented Crawlspace	R-6 or R-4.2
Conditioned Crawlspace	NR
Basement – Conditioned	NR
Basement – Unconditioned	R-6 or R-4.2
Exterior Walls	R-6 or R-4.2

Duct Sealing

Section R403.3.2 - Mandatory

- ✓ Sealing (Mandatory)
 - Joints and seams to comply with IMC or IRC
 - All ducts, air handlers, and filter boxes to be sealed (*Section R403.3.2.1*)



- Ducts shall be pressure tested to determine air leakage by either of the following:
 - Rough-in test
 - Total leakage measured with a pressure differential of 0.1 inch w.g. (25 Pa) across the system including manufacturer's air handler enclosure
 - All registers taped or otherwise sealed
 - Postconstruction test
 - Total leakage measured with a pressure differential of 0.1 inch w.g. (25 Pa) across the entire system including manufacturer's air handler enclosure
 - All registers taped or otherwise sealed
 - **Exceptions**
 - Duct air leakage test not required where ducts and air handlers are entirely within the building thermal envelope
 - **Test not required for ducts serving heat or energy recovery ventilators not integrated with ducts serving heating or cooling systems**
- A written report of results of test signed by the party conducting test and provided to code official

Total leakage of ducts, where measured in accordance with Section 403.3.3 shall be as follows:

✓ Rough-in test

- Total leakage ≤ 4 cfm/per 100 ft² of conditioned floor area
 - if air handler not installed at time of test
 - » Total air leakage ≤ 3 cfm/per 100 ft²

✓ Postconstruction test

- Total leakage ≤ 4 cfm/per 100 ft² of conditioned floor area

Duct Tightness Tests

Section R403.3.3



Sealed Air Handler

Section R403.3.2.1 - Mandatory

Air handlers to have a manufacturer's designation for an air leakage of $\leq 2\%$ of design air flow rate per ASHRAE 193



Building Cavities

Section R403.3.5 - Mandatory

Framing cavities cannot be used as ducts or plenums



Prior to 2018, the IECC did not prohibit buried ducts, but neither did it define the practice or make specific allowance for it. The new provisions:

1. Define buried-duct practices that are explicitly allowed
2. Provide a means to characterize the performance of a buried duct system as an equivalent duct insulation R-value
3. Allow simplified credit for buried ducts in the performance path
 - Buried duct system may be considered inside conditioned space if certain requirements are met

- Where supply and return air ducts are partially or completely buried in ceiling insulation, such ducts shall comply with all of the following:
 - 1. The supply and return ducts shall have an insulation *R*-value not less than R-8.
 - 2. At all points along each duct, the sum of the ceiling insulation *R*-value against and above the top of the duct, and against and below the bottom of the duct, shall be not less than R-19, excluding the *R*-value of the duct insulation.
 - 3. In *Climate Zones* 1A, 2A and 3A, the supply ducts shall be completely buried within ceiling insulation, insulated to an *R*-value of not less than R-13 and in compliance with the vapor retarder requirements of Section 604.11 of the *International Mechanical Code* or Section M1601.4.6 of the *International Residential Code*, as applicable.
- **Exception:** Sections of the supply duct that are less than 3 feet (914 mm) from the supply outlet shall not be required to comply with these requirements.

- Where using a simulated energy performance analysis, sections of ducts that are:
 - installed in accordance with Section R403.3.6
 - located directly on, or within 5.5 inches (140 mm) of the ceiling
 - surrounded with blown-in attic insulation having an *R*-value of R-30 or greater
 - located such that the top of the duct is not less than 3.5 inches (89 mm) below the top of the insulation
- shall be considered as having an effective duct insulation *R*-value of R-25

For simulated performance path, buried ducts may be considered inside conditioned space if:

1. The duct system is actually located completely within the continuous air barrier and within the building thermal envelope, OR
2. The ducts are buried within ceiling insulation in accordance with Section R403.3.6 and all of the following conditions exist:
 - 2.1. The air handler is located completely within the *continuous air barrier* and within the building thermal envelope.
 - 2.2. The duct leakage, as measured either by a rough-in test of the ducts or a post-construction total system leakage test to outside the building thermal envelope in accordance with Section R403.3.4, is less than or equal to 1.5 cubic feet per minute (42.5 L/min) per 100 square feet (9.29 m²) of conditioned floor area served by the duct system.
 - 2.3. The ceiling insulation *R*-value installed against and above the insulated duct is greater than or equal to the proposed ceiling insulation *R*-value, less the *R*-value of the insulation on the duct.

Mechanical System Piping Insulation

Section R403.4 - Mandatory

- ✓ R-3 required on
 - HVAC systems
 - Exception: Piping that conveys fluids between 55 and 105°F
- If exposed to weather,
 - protect from damage, including
 - Sunlight
 - Moisture
 - Equipment maintenance
 - Wind
 - Provide shielding from solar radiation that can cause degradation of material
 - Adhesive tape is not allowed

Service Hot Water Systems

Section R403.5

- Heated water circulation systems
- Heat trace systems
- Demand recirculation water systems

Heated Water Circulation and Temp. Maintenance Systems

Section R403.5.1 - Mandatory

- Heated water circulation systems
 - provided with circulation pump
 - return pipe must be a dedicated return pipe or a cold water supply pipe
 - gravity and thermosyphon circulation systems are prohibited
- Controls shall
 - start the pump based on identification of the demand for hot water within the occupancy
 - automatically turn off pump when water in the loop is at desired temperature and there is no demand for hot water
- Automatic controls, temperature sensors, and pumps shall be accessible
- Manual controls shall be readily accessible

- Electric heat trace systems shall comply with IEEE 515.1 or UL 515
- Controls shall automatically adjust the energy input to the heat tracing to maintain the desired water temperature in the piping in accordance with the times when heated water is used in the occupancy

- Demand recirculation water system to have controls that
 - start pump upon:
 - receiving a signal from action of user of a fixture or appliance
 - sensing the presence of a user of a fixture or
 - sensing the flow of hot or tempered water to a fixture fitting or appliance
 - limit the temperature of water entering cold water pipe to **not greater than** 104°F

Hot Water Pipe Insulation

Section R403.5.3 - Prescriptive

- R-3 required on
 - Piping $\geq \frac{3}{4}$ in. nominal diameter
 - Piping serving more than one dwelling unit
 - Piping located outside the conditioned space
 - Piping from the water heater to a distribution manifold
 - Piping under a floor slab
 - Buried piping
 - Supply and return piping in recirculating systems other than demand recirculation systems



Image courtesy of Ken Baker, K energy

- Comply with CSA B55.2 and tested in accordance with CSA B55.1
- Portable water-side pressure loss of drain water heat recovery units shall be < 3 psi for individual units connected to 1 or 2 showers
 - < 2 psi if connected to ≥ 3 showers

✓ Ventilation

- Building to have ventilation complying with IRC or IMC or with other approved means
- Outdoor air intakes and exhausts shall have automatic or gravity dampers that close when the ventilation system is not operating

✓ Whole-house mechanical ventilation system fans to meet efficacy in Table R403.6.1

✓ Exception

- ✓ When **an air handler** integral to tested and listed HVAC equipment **is used to provide whole-house mechanical ventilation, the air handler** shall be powered by an electronically commutated motor

✓ Equipment Sizing

- Load calculations determine the proper capacity (size) of equipment
 - Goal is big enough to ensure comfort but no bigger
- Sizing shall be performed in accordance with ACCA Manual S based on loads calculated in accordance with ACCA Manual J (other approved methods)

✓ Efficiency Rating

- New or replacement heating/cooling equipment shall have an efficacy rating equal to or greater than minimum required by federal law for geographic location of installation

Snow- and ice-melting system controls

- ✓ Automatic shutoff when pavement temperature is $> 50^{\circ}\text{F}$ and precipitation is not falling
- ✓ Automatic or manual shutoff when outdoor temperature is $> 40^{\circ}\text{F}$

Pools and Permanent Spa Energy Consumption

Section R403.10 - Mandatory

- ✓ Pools and spas in accordance with APSP-145
- ✓ Heaters
 - with a readily accessible on-off switch that is integral part of heater mounted on the exterior of heater or external to within 3 feet of heater
 - Switch shall not change the setting of heater thermostat
 - Switches shall be in addition to the circuit breaker for the power to the heater
 - fired by natural gas not allowed to have continuously burning pilot lights
- ✓ Time switches (or other control method) to automatically turn off and on heaters and pumps according to a preset schedule installed on all heaters and pump motors
- ✓ Note: heaters, pumps, and motors with built-in timers meet the requirement
 - Exceptions
 - Public health standards requiring 24-hour pump operation
 - Pumps operating pools with solar and waste-heat recovery heating systems



On outdoor heated pools and outdoor permanently installed spas

- ✓ Vapor-retardant cover OR
- ✓ Other approved vapor retarder means

Exception:

- ✓ If >75% of energy from **on-site renewable energy system**



Portable Spas

Section R403.11 - Mandatory

- Energy consumption of electric-powered portable spas shall be controlled by the requirements of APSP14



Systems serving multiple dwelling units shall comply with Sections C403 and C404 **instead** of Section R403



Lighting Equipment

Section R404.1 - Mandatory

A minimum of **90** percent of the permanently installed lighting fixtures shall contain only high efficacy lamps



Lighting Equipment

Section R404.1.1 - Mandatory

Fuel gas lighting systems may not have continuously burning pilot lights

Existing Buildings

Section R501 - General

- ✓ Additions, alterations, or repairs
- ✓ Existing buildings
- ✓ Maintenance
- ✓ Compliance
- ✓ New and replacement materials
- ✓ Buildings designated as historic

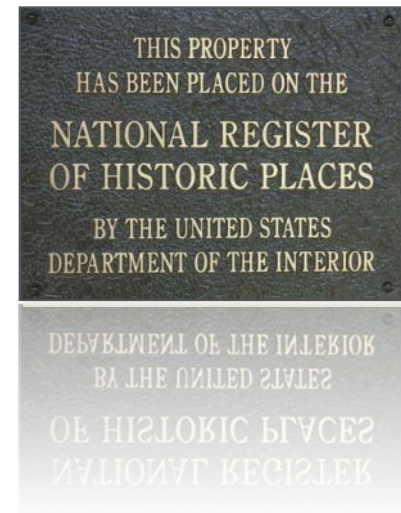

Existing Buildings

Section R502 - Additions

- ✓ Additions must meet the prescriptive requirements in Table R402.1.2 or R402.1.4 (*R-value computation or U-factor or total UA alternatives*)



- ✓ Additions comply if any of the following is demonstrated
 - ✓ The addition alone complies with the provisions of this code
 - ✓ The existing building and addition together comply as a single building
 - ✓ The existing building and addition together use no more energy than the existing building

Existing Buildings

Section R503 - Alterations



Code applies to any new construction

Unaltered portion(s) do not need to comply

(R503.1.1.1) Replacement fenestration that includes both glazing and sash must meet

- ✓ 0.25 SHGC in **Climate Zones 1-3**
- ✓ 0.40 SHGC in **Climate Zone 4 except Marine**
- ✓ U-factors in all **Climate Zones 1-8**

Where more than 1 replacement fenestration unit is to be installed, an area-weighted average U-factor, SHGC or both of all replacement fenestration units can be an alternative compliance approach.

Building Envelope

Exceptions:

- ✓ Storm windows over existing fenestration
- ✓ Surface-applied window film installed on existing single pane
- ✓ Exposed, existing ceiling, wall or floor cavities if already filled with insulation
- ✓ Where existing roof, wall or floor cavity isn't exposed
- ✓ Roof recover
- ✓ Roofs without cavity insulation and neither sheathing nor insulation is exposed during the reroofing
 - Insulate either above or below the sheathing

Lighting

Exceptions:

- ✓ <50% of luminaries in a space are replaced
- ✓ Only bulbs and ballasts within existing luminaries are replaced (provided installed interior lighting power isn't increased)

- Heating and Cooling
 - New HVAC systems and duct systems that are part of the alteration to comply with Section 403
 - Exception: Where duct from on existing HVAC system are extended, duct systems with < 40 linear feet in unconditioned spaces are not required to be tested in accordance with Section R403.3.3
- Service hot water (SHW) systems
 - New SHW systems that are part of the alteration to comply with R403.5

- Work on nondamaged components necessary for the required repair or damaged components shall be considered part of the repair and are not subject to the alterations requirements
- Repairs considered part of the code
 - Glass-only replacements in an existing sash and frame
 - Roof repairs
 - Repairs where only the bulb, ballast **or both** within the existing luminaires in a space are replaced provided the replacement does not increase the installed interior lighting power